

fora_care

: product card



bejot:

fora_care

design:
Kasper Mose

models



FC F 100



FC F 200



FC F 300



FC S 200



FC S 300



FC F 401



FC F 402



FC F 412L



FC F 422



FC F 403



FC F 413L



FC F 423



FC S 402 +
FC A OUT + FC TB SDO



FC S 402 +
2 x FC A OUT + FC A IN



FC S 403



FC S 403 +
2 x FC A OUT + 2 x FC A IN



FC S 412L



FC S 422



FC S 413R



FC S 423

base

Powder-coated metal frame (structure).



RAL 9003S



RAL 7024S



RAL 9005S



additional colors



● Standard, freestanding construction



○ FM Floor-mountable construction

seats



FC F
Full, undivided one-, two-, and three-seater

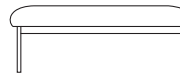
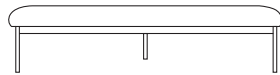

FC S
Divided seat, two- and three-seater

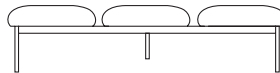

feet (not available for floor-mounted base – FM)



● **TK**
feet for soft floor



○ **TF**
felt feet for hard floor

● standard ○ option

mediaport



R[type]IV
 round PIX mediaport
 (black-B) – 1 voltage
 socket 230 V
 The type of electrification
 should be specified for
 mediaports:
 type E – Poland, France
 type F – Germany
 type G – United Kingdom



RM1CC
 round PIX mediaport
 (black-B) – 2 x USB
 charger

possibilities of placing mediaports

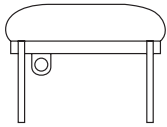

max. 1 mediaport
 FCF 100, FCF 401

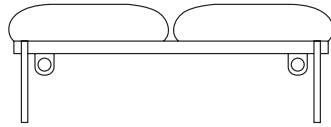

max. 2 mediaports
 FCF 200, FCS 200, FCF 300, FCS 300, FCF 4X2, FCF 4X3, FCS 4X2, FCS 4X3

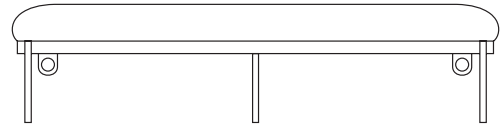

armrests mounted on the edge of the sofa

(only available for models with a backrest, excluding model FC F 401)



○ **FC A OUT**
 armrest mounted on the edge
 of the sofa (powder coated in
 the color of the base + natural
 oak wood pad - clear varnish)
 Can be mounted on both sofas
 with a split and a full seat (FC S
 and FC F).



○
 armrest mounted on
 the edge of the sofa
 (upholstered).
 Can be mounted on
 both sofas with a split
 and a full seat (FC S
 and FC F).

armrests mounted between the seats

(only available for versions with backrest)



○ **FC A IN**
 Armrest mounted between the seats (powder coated in the color of the base + natural oak wood pad - clear varnish).
 Armrests FC A IN can only be mounted on sofas with a split seat FC S.
 Upholstered armrests cannot be combined with powder coated armrests with a wooden overlay.

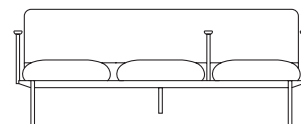
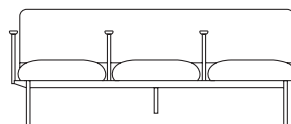
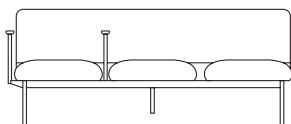
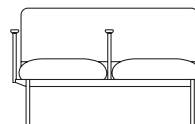
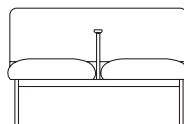
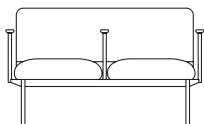

models | coffee tables



FR TB 65A



FR TB 80



FR TB 13

tabletop

laminated board



H3303 ST10
Hamilton



H1180 ST37
Halifax



white



U708 ST9



U961 ST2

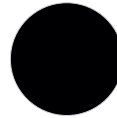

black

finger joint solid oak (option)



KDAB
oak

edge of the countertop



countertop with a straight edge

applies to countertops made of laminated board



countertop with a bottom radius edge (R16)

applies to countertops made of finger joint solid oak

table mounted between the seats



table mounted between the seats, dla modeli dwu- i trzyosobowych

- o **FC TB SDL** – table with top made of laminated board
- o **FC TB SDO** – table with top made of finger joint solid oak

connectors and tops

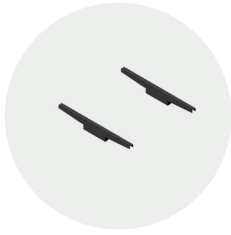

FC L1
sofa connector
(powder-coated
construction)

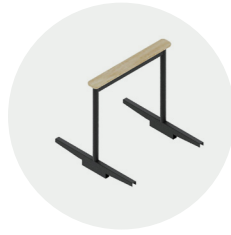

FC L1 A
sofa connector with armrest
(powder-coated construc-
tion, natural wood overlay
(oak) – clear lacquer)

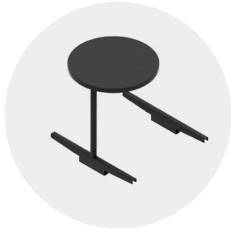

FC L1 SD
sofa connector with round
table (Ø320 mm) (powder-
coated construction, top
made of laminated board
or oak blockboard)

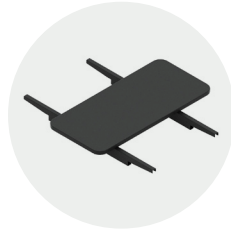

FC L2 TB
sofa connector with top
(305x685 mm) (powder-
coated construction, top
made of laminated board
or oak blockboard)



FC L2 TB E
side-mounted sofa table
(305x685 mm) (powder-
coated construction, top
made of laminated board
or oak blockboard). The
top can only be mounted
on sets with a minimum of
4 seats.

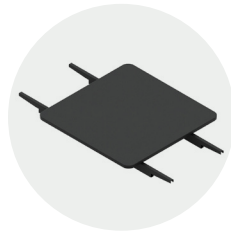

FC L3 TB
sofa connector with top
(650x650 mm) (powder-
coated construction, top
made of laminated board
or oak blockboard)



FC LC TB IN
sofa connector with top
(685x685 mm) connecting
sofas at a 90° angle fac-
ing each other (powder-
coated construction, top
made of laminated board
or oak blockboard)

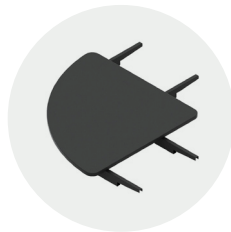

FC LC TB OUT
sofa connector with top
(685x685 mm) connecting
sofas at a 90° angle back-
-to-back (powder-coated
construction, top made of
laminated board or oak
blockboard)



FC LC TB IN



FC LC TB OUT



FC L2 TB E



FC L3 TB

back walls

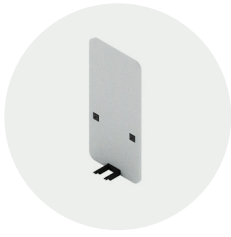

FC SC 1
Acoustic panel connecting two single sofas

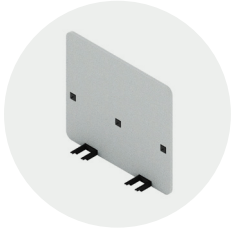

FC SC 2
Acoustic panel connecting two two-seater sofas

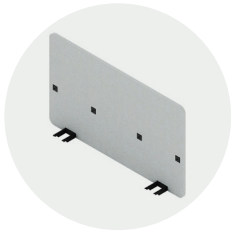

FC SC 3
Acoustic panel connecting two three-seater sofas

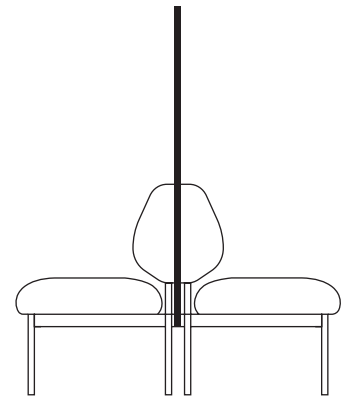

acoustic walls available only between two sofas with backrests



2 x FC F 401 + FS SC 1



2 x FC S 402 + FS SC 2



2 x FCS 403 + FS SC 3

seat upholstery configuration



bejot: 8

possibilities of using fabrics in individual products

1 grp.	2 grp.	3 grp.	4 grp.	5 grp.
fenno	alpa charles charles SD cura pastel roccia valencia	ally ally SD cura SD blazer easy oceanic silvertex silvertex SD synergy synergy SD valencia SD	heritage SD remix SD	steelcut trio SD

For easy cleaning, we recommend **valencia** and **silvertex** fabrics.

recycling

97% of the materials used in the FC S 402 + 2 x FC A OUT model can be recycled.

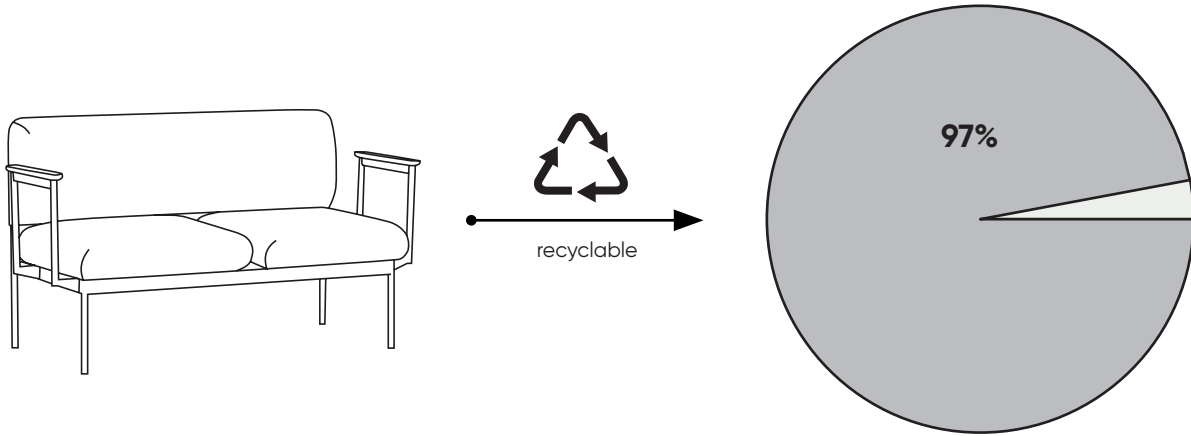

material composition

Percentage by mass of each raw material in model FC S 402 + 2 x FC A OUT

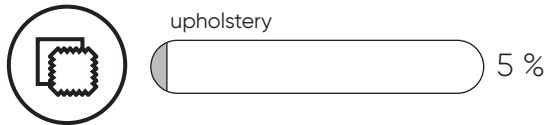
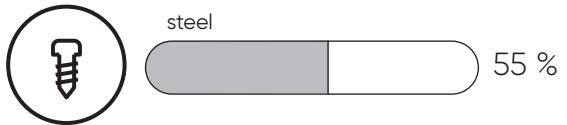
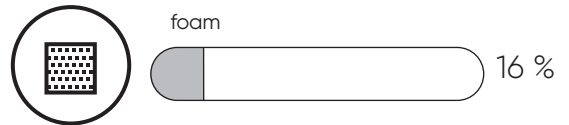

technical data

All dimensions are in inches and refer to basic version products. The indicated dimensions can change depending on the selected equipment package. Bejot reserves the right to change selected elements and this may slightly affect the product's dimensions. In case of any special requirements on dimensions of a given product, the afore-mentioned information should be acknowledged by the Producer.

The specification does not constitute an offer within the meaning of the Civil Code.

Dimensions and weights are approximate and may vary by 5%. The data is given for the basic configuration of products. The requirements of the standard are always met.

- A seat height: overall dimensions
- B seat height: measured according to the norm PN EN 1335-1 with a load of 640N
- C chair height: overall dimensions
- D backrest height
- F chair width: overall dimensions
- G seat width
- H backrest width
- K height from the floor to the armrest
- M chair depth: overall dimensions
- N seat depth / seat length

FC F 100

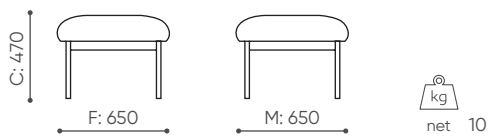

FC F 200

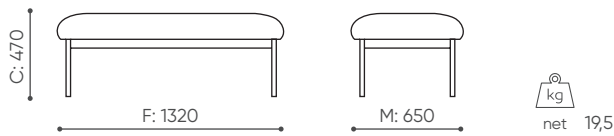

FC F 300

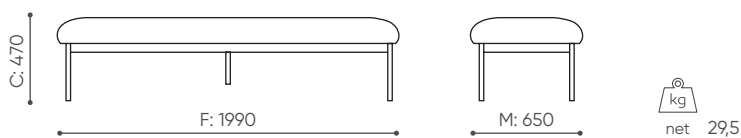

FC S 200

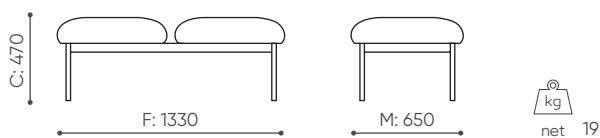

FC S 300

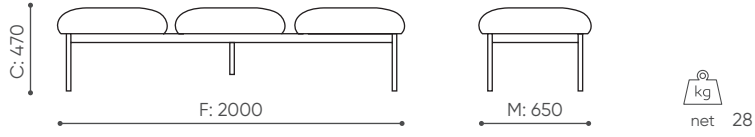

FC F 401

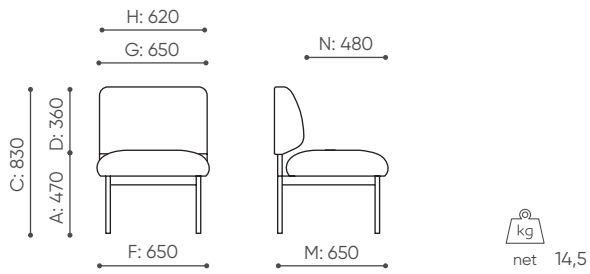

FC F 402

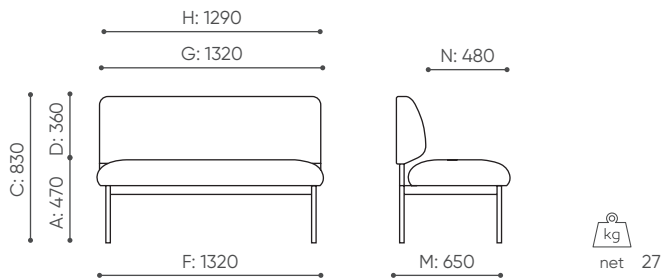

FC F 403

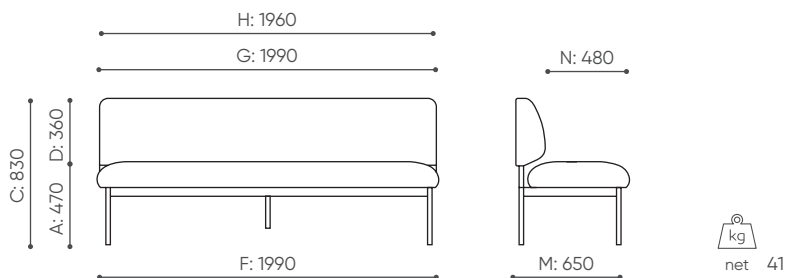

FC F 422

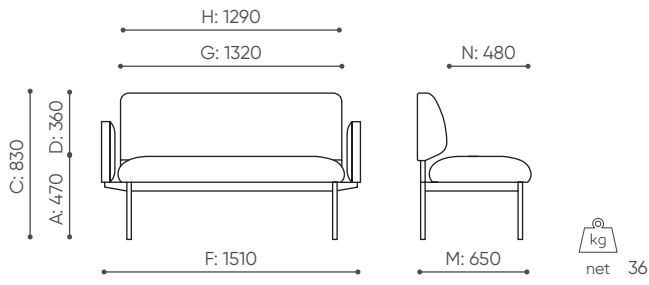

FC F 423

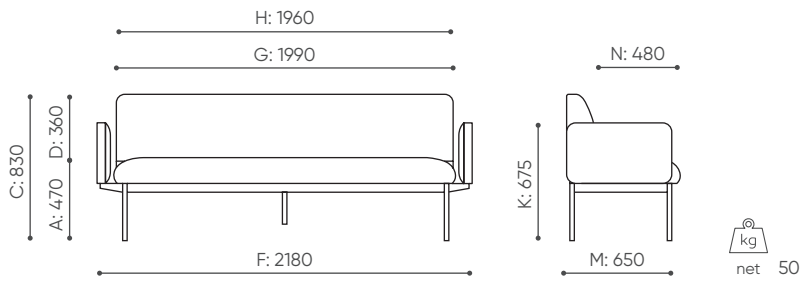

FC S 422

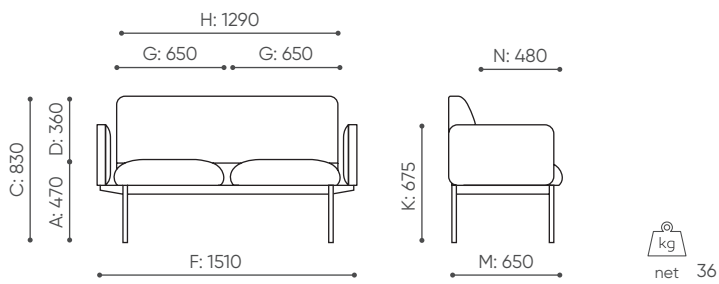

FC S 423

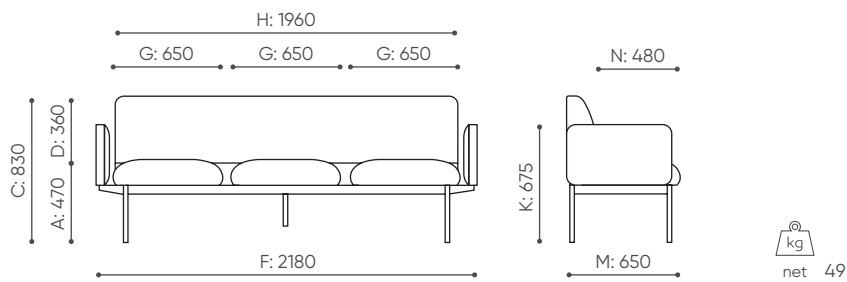

FC S 402

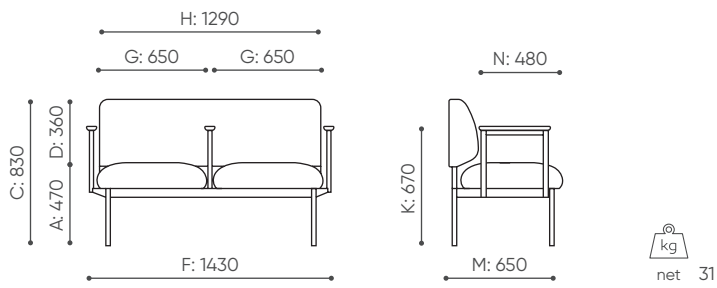

FC S 423

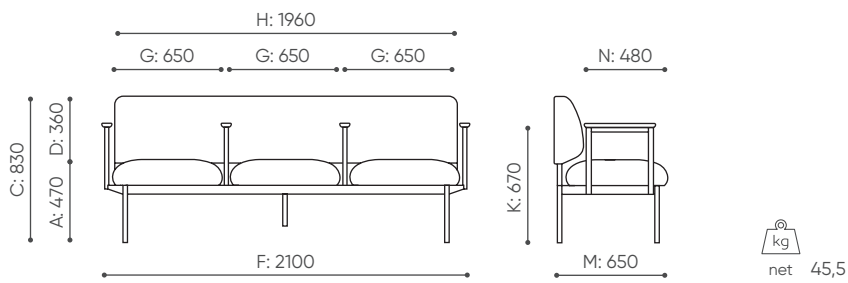

FC SC 1 / FC SC 2 / FC SC 3

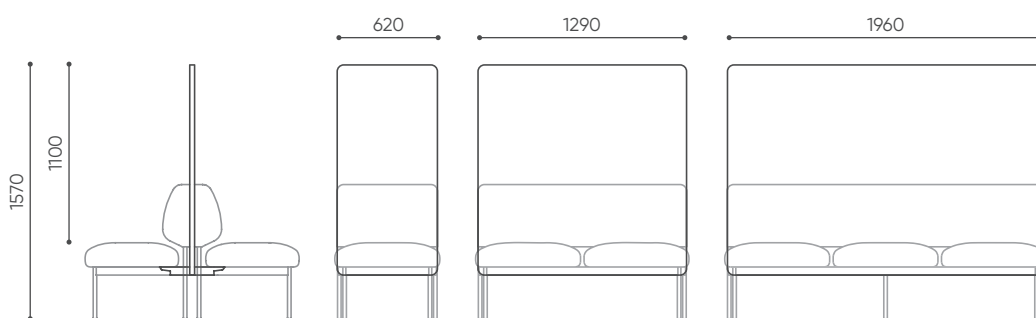

	SC1	SC2	SC3
H:	100	100	100
W:	640	1310	1980
L:	1170	1170	1170
kg net	SC1 10,5	SC2 25,5	SC3 31,5

FC L1

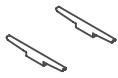

H: 50
W: 50
L: 400
net
1 kg

FC L1 A

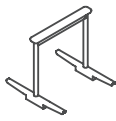

H: 50
W: 50
L: 400
net
2 kg

FC L1 SD

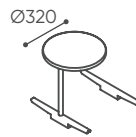

H: 40
W: 400
L: 400
net
2,5 kg

FC L1

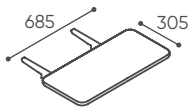

H: 40
W: 650
L: 305
net
4,5 kg

FC L1 A

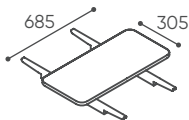

H: 40
W: 730
L: 305
net
3,5 kg

FC L1 SD

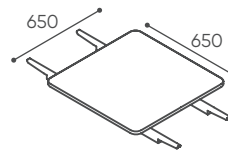

H: 40
W: 650
L: 1070
net
8 kg

FC L1

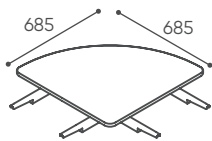

H: 70
W: 710
L: 710
net
7,5 kg

FC L1 A

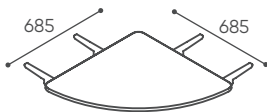

H: 70
W: 710
L: 710
net
7,5 kg

FR TB 65A

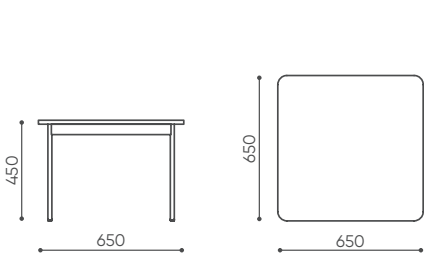

H: 400
W: 810
L: 810
1 szt.
St.
pc.
kg
net 11
gross 13

FR TB 80

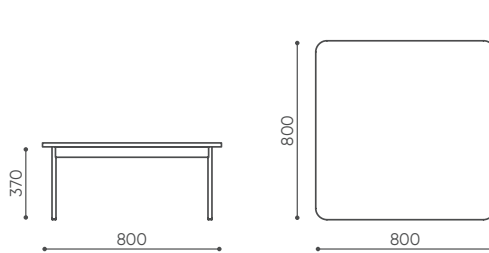

H: 400
W: 810
L: 810
1 szt.
St.
pc.
kg
net 13,5
gross 15,5

FR TB 65A

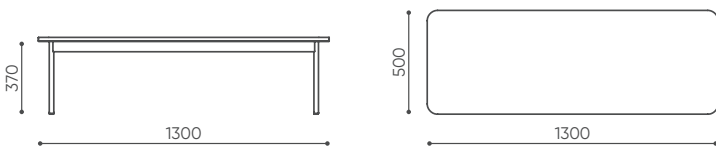

H: 430
W: 510
L: 1310
1 szt.
St.
pc.
kg
net 15
gross 17,5

Bejot sp. z o. o.

ul. Wybickiego 2A, Manieczki, 63-112 Brodnica n. Poznań, POLAND

www.bejot.eu

edition 09/2024