

# fora\_care

: fiche technique



**bejot:**

# fora\_care

design:  
Kasper Mose

## modèles



FC F 100



FC F 200



FC F 300



FC S 200



FC S 300



FC F 401



FC F 402



FC F 412L



FC F 422



FC F 403



FC F 413L



FC F 423



FC S 402 +  
FC A OUT + FC TB SDO



FC S 402 +  
2 x FC A OUT + FC A IN



FC S 403



FC S 403 +  
2 x FC A OUT + 2 x FC A IN



FC S 412L



FC S 422



FC S 413R



FC S 423

## Base

Cadre métallique peint par poudrage (structure).



RAL 9003S



RAL 7024S



RAL 9005S



couleurs  
supplémentaires



- Construction standard, autoportante



- FM Construction à montage au sol

## sièges



- FC F Assise pleine, non divisée une, deux et trois place

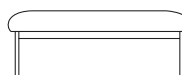
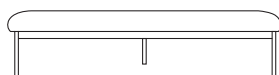

- FC S Assise divisée, pour deux ou trois personnes

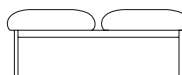
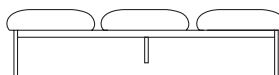

## Pieds (non disponibles pour la version au sol – FM)



- TK Pieds pour sol souple



- TF Pieds en feutre pour sol dur

## mediaport



### R[type]IV

PIX mediaport rond (noir-B) –  
1 prise de courant 230 V.

Le type d'électrification doit être  
spécifié pour les ports média:  
type E - Pologne, France  
type F - Allemagne  
type G - Royaume Uni



### RM1CC

PIX mediaport rond  
(noir-B) – 2 x chargeur USB

## Possibilités de placer des mediaports

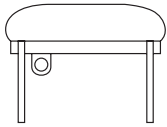

### max. 1 mediaport

FCF 100, FCF 401

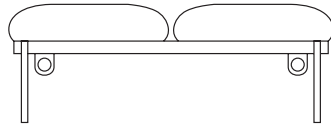

### max. 2 mediaports

FCF 200, FCS 200, FCF 300, FCS 300, FCF 4X2, FCF 4X3, FCS 4X2, FCS 4X3

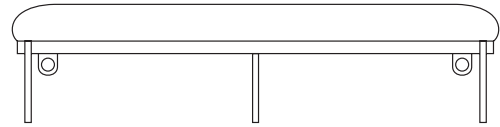

## Accoudoir monté au bord du canapé

(disponible uniquement pour les versions avec dossier, à l'exception du modèle FC F 401)



### o FC A OUT

Accoudoir monté sur le bord du  
canapé (peint par poudrage  
de la couleur de la structure +  
dessus en bois de chêne naturel  
- vernis transparent).

Peut être monté sur des cana-  
pés avec une assise divisée et  
une assise pleine (FC S et FC F).



### o

Accoudoir monté sur  
le bord du canapé  
(tapissé).

Peut être monté sur  
des canapés avec une  
assise divisée et une  
assise pleine (FC S et  
FC F).

## Accoudoir monté entre les sièges

(uniquement disponible pour les versions avec dossier)



### o FC A IN

Accoudoir monté entre les assises (peint par poudrage de la couleur de la structure +  
dessus en bois de chêne naturel - vernis transparent).

Les accoudoirs FC A IN ne peuvent être montés que sur des canapés avec une assise  
divisée FC S.

Les accoudoirs rembourrés ne peuvent pas être combinés avec les accoudoirs peints par  
poudrage avec un dessus en bois.

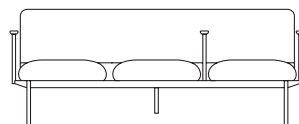
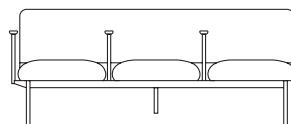
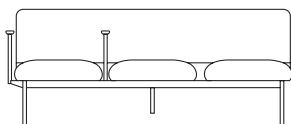
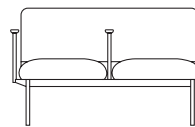
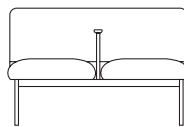
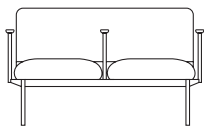

## modèles | tables basses



FR TB 65A



FR TB 80



FR TB 13

### Plateau de table

#### Plateau en bois stratifié



H3303 ST10  
Hamilton



H1180 ST37  
Halifax



blanc



U708 ST9



U961 ST2



noir

#### Chêne en lamellé collé (option)



KDAB  
chêne

### bord du comptoir



#### angle droit

s'applique aux comptoirs  
en panneaux stratifiés



#### bord du plan de travail arrondi

Rayon du dessous du plan  
de travail = R16.

Concerne les plans de travail  
en chêne contrecollé.

### tables montées sur le canapé



Tablette montée entre les sièges, pour modèles deux et trois places

○ **FC TB SDL** – table avec plateau stratifié

○ **FC TB SDO** – table avec plateau en panneau de chêne

## connecteurs et plateaux

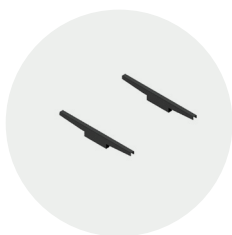

**FC L1**  
connecteur de canapé  
(construction thermolaquée)

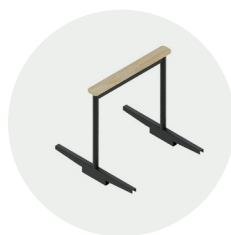

**FC L1 A**  
connecteur de canapé  
avec accoudoir  
(construction thermolaquée, revêtement en bois naturel (chêne) – vernis transparent)

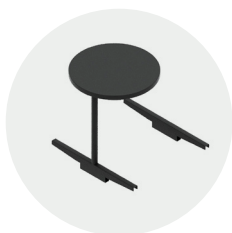

**FC L1 SD**  
connecteur de canapé avec table ronde (Ø320 mm) (construction thermolaquée, plateau en panneau stratifié ou panneau en chêne)

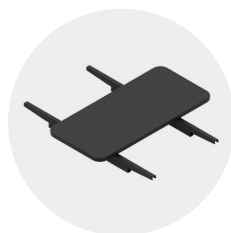

**FC L2 TB**  
connecteur de canapé avec plateau (305x685 mm) (construction thermolaquée, plateau en panneau stratifié ou panneau en chêne)



**FC L2 TB E**  
tableau monté sur le côté du canapé (305x685 mm) (construction thermolaquée, plateau en panneau stratifié ou panneau en chêne). Le plateau peut être monté uniquement sur des ensembles ayant au moins 4 sièges.

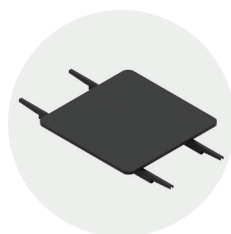

**FC L3 TB**  
connecteur de canapé avec plateau (650x650 mm) (construction thermolaquée, plateau en panneau stratifié ou panneau en chêne)



**FC LC TB IN**  
connecteur de canapé avec plateau (685x685 mm) reliant les canapés à un angle de 90° face à face (construction thermolaquée, plateau en panneau stratifié ou panneau en chêne)

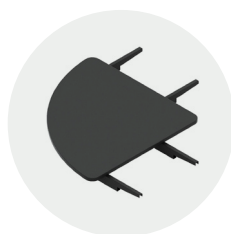

**FC LC TB OUT**  
connecteur de canapé avec plateau (685x685 mm) reliant les canapés à un angle de 90° dos à dos (construction thermolaquée, plateau en panneau stratifié ou panneau en chêne)



FC LC TB IN



FC LC TB OUT



FC L2 TB E



FC L3 TB



## Cloisons arrières

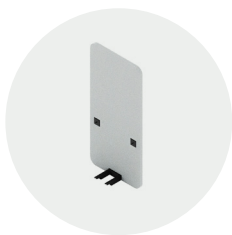

### FC SC 1

Panneau acoustique reliant deux canapés simples

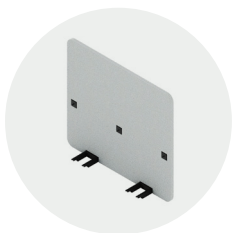

### FC SC 2

Panneau acoustique reliant deux canapés deux places

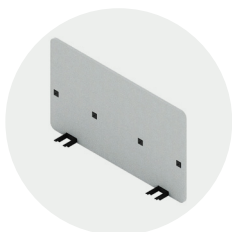

### FC SC 3

Panneau acoustique reliant deux canapés trois places

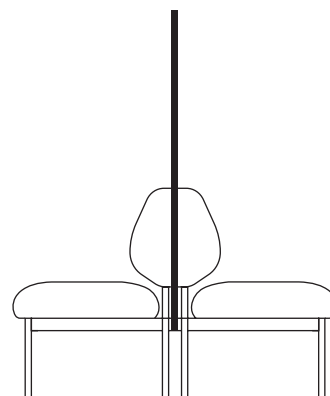

Cloisons acoustiques disponibles uniquement entre 2 canapés avec dossier



2 x FC F 401 + FS SC 1



2 x FC S 402 + FS SC 2



2 x FCS 403 + FS SC 3

## Configuration de la tapisserie d'un siège

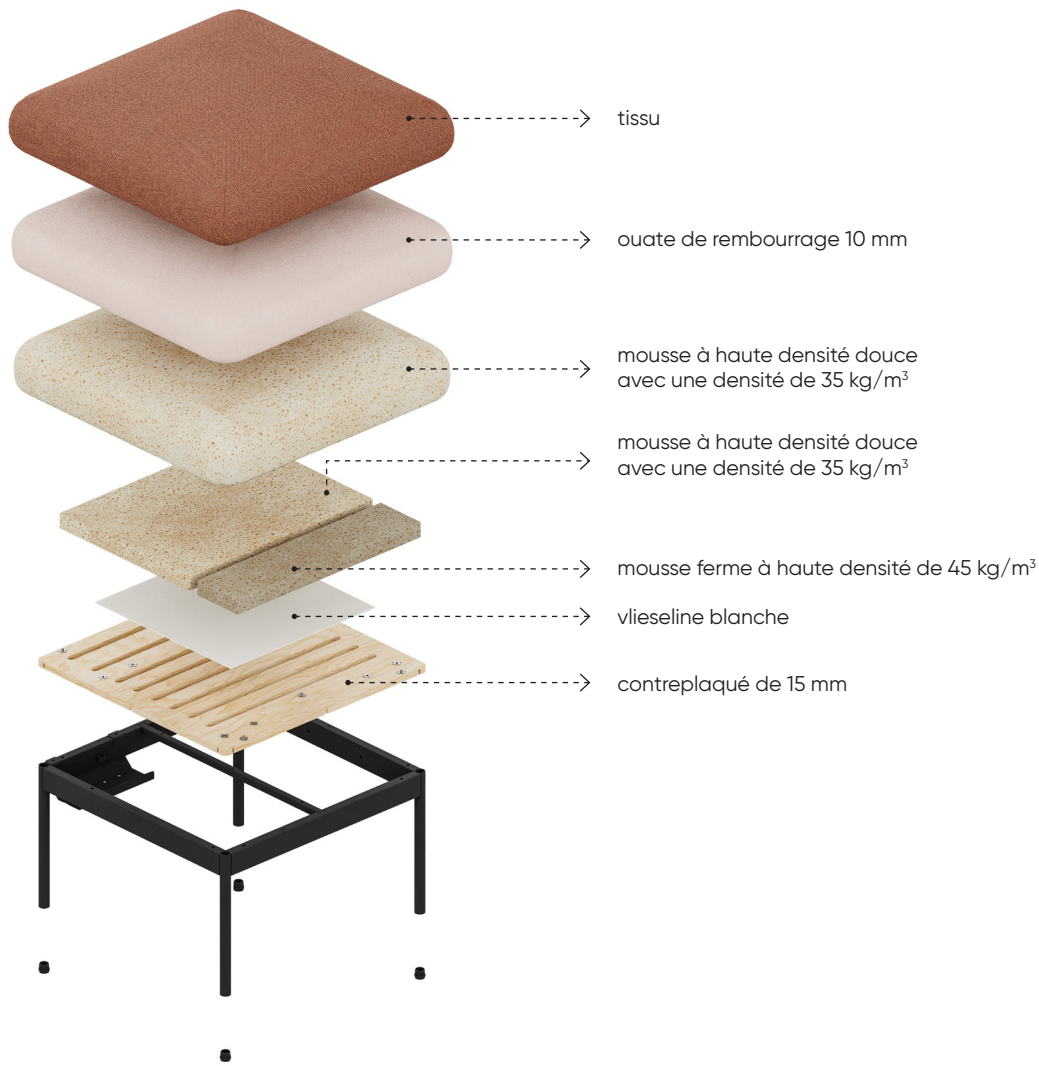

bejot: 8

## Applications de tissus dans Fora\_care

1 gp.	2 gp.	3 gp.	4 gp.	5 gp.
fenno	alpa charles charles SD cura pastel roccia <b>valencia</b>	ally ally SD cura SD blazer easy oceanic <b>silvertex</b> <b>silvertex SD</b> synergy synergy SD <b>valencia SD</b>	heritage SD remix SD	steelcut trio SD

Pour un entretien facile, nous recommandons les tissus **valencia** et **silvertex**.



## Recyclage

97% des matériaux utilisés dans le modèle FC S 402 + 2 x FC A OUT sont recyclables.

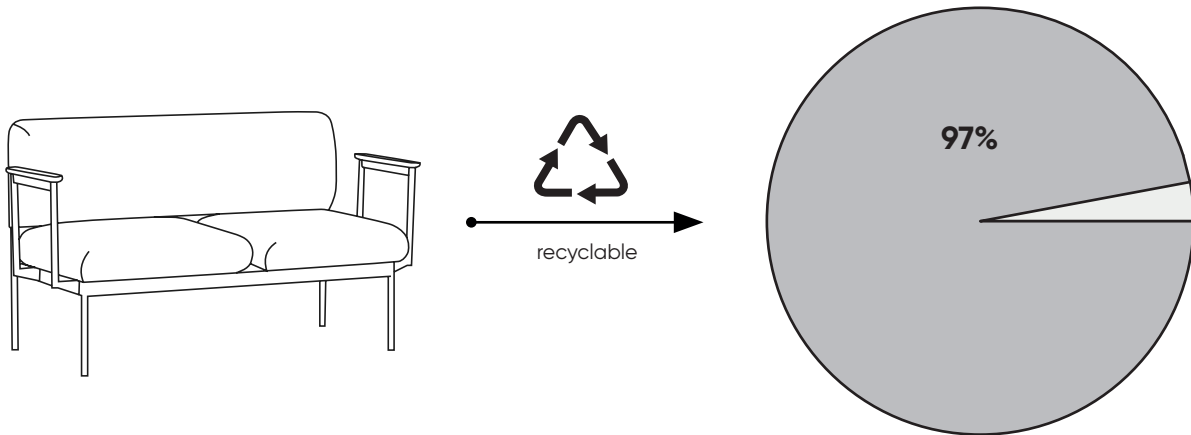

## Composition matérielle

Pourcentage du poids d'une matière première donnée dans le modèle FC S 402 + 2 x FC A OUT:

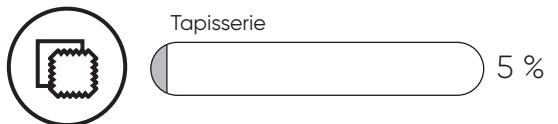
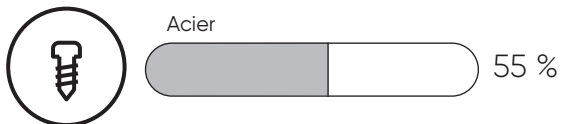
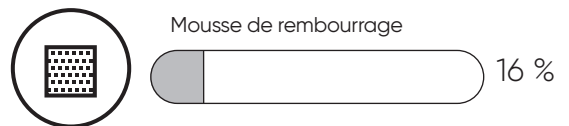
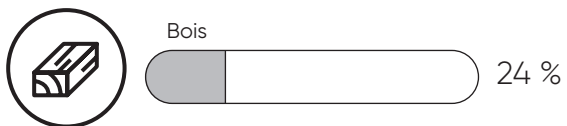

## Dimensions techniques

Les dimensions indiquées sont en [mm] et concernent les produits dans leur version de base. Les dimensions indiquées peuvent être modifiées en fonction des options d'équipement choisis. Bejot se réserve le droit de modifier certains éléments, ce qui peut avoir un impact minime sur les dimensions du produit.

En cas de besoins spécifiques concernant les dimensions d'un produit donné, veuillez confirmer les informations ci-dessus auprès du fabricant.

Les spécifications ne constituent pas une offre au sens du Code civil.

Les dimensions et les poids sont donnés à titre indicatif et peuvent varier de 5%. Les données fournies concernent les configurations de base des produits.

Les normes sont toujours respectées.

- A hauteur d'assise: dimensions hors tout
- B hauteur d'assise: mesurée selon la norme PN EN 1335-1 avec une charge de 640N
- C hauteur de la chaise: dimensions hors tout
- D hauteur du dossier
- F largeur de la chaise: dimensions hors tout
- G largeur de l'assise
- H largeur du dossier
- K hauteur du sol à l'accoudeoir
- M profondeur du fauteuil: dimensions hors tout
- N profondeur de l'assise / longueur de l'assise

### FC F 100

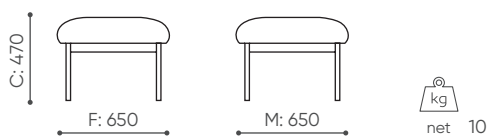

### FC F 200

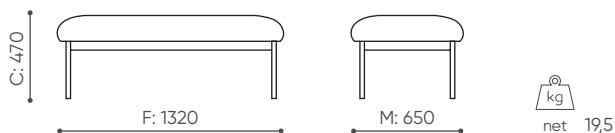

### FC F 300

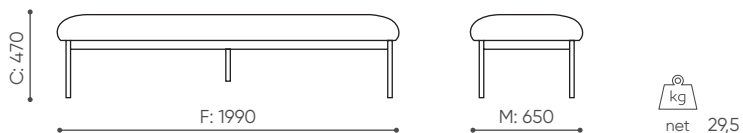

### FC S 200

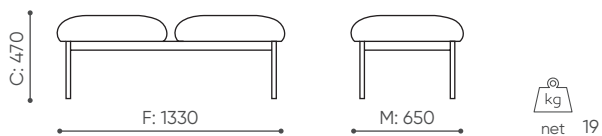

### FC S 300

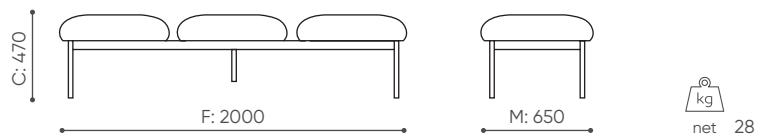

### FC F 401

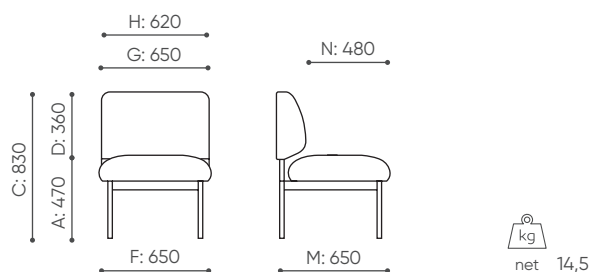

### FC F 402

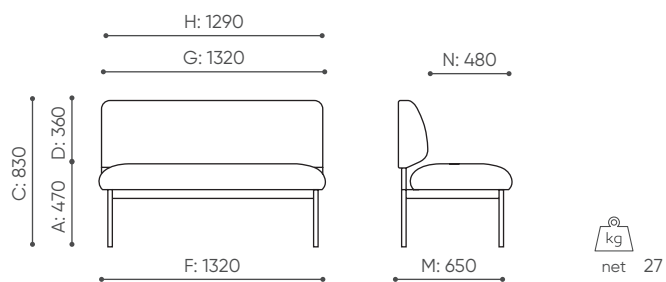

### FC F 403

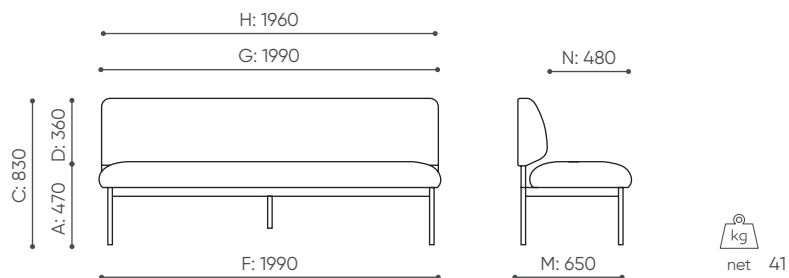

FC F 422

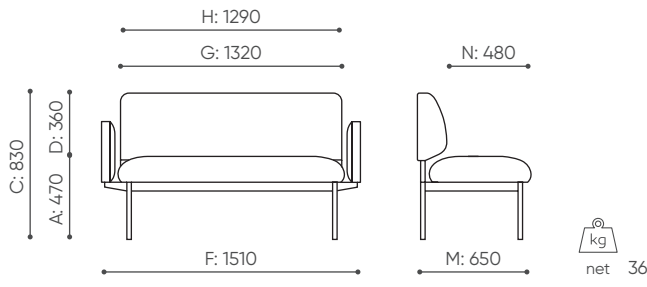

FC F 423

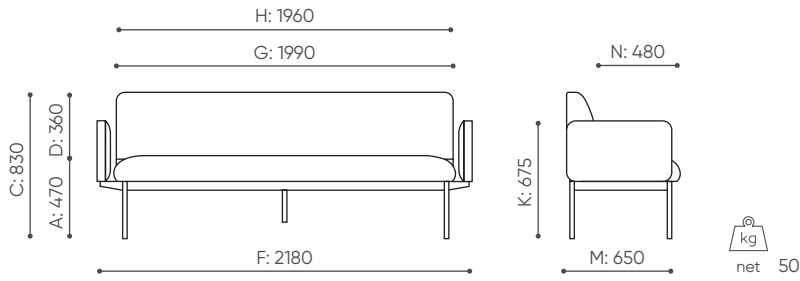

FC S 422

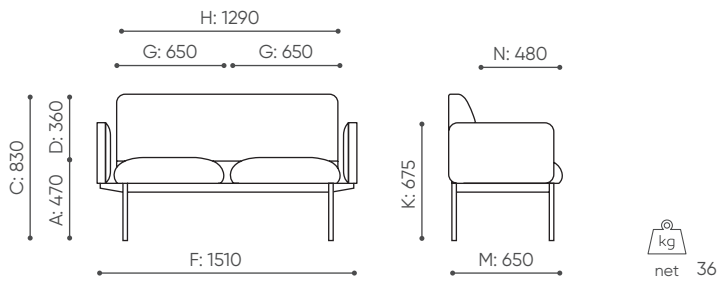

FC S 423

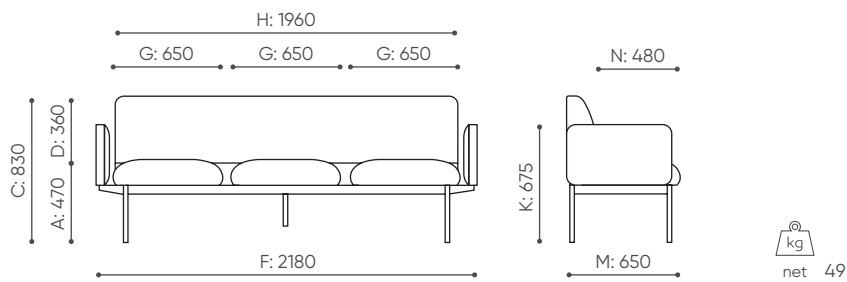

## FC S 402

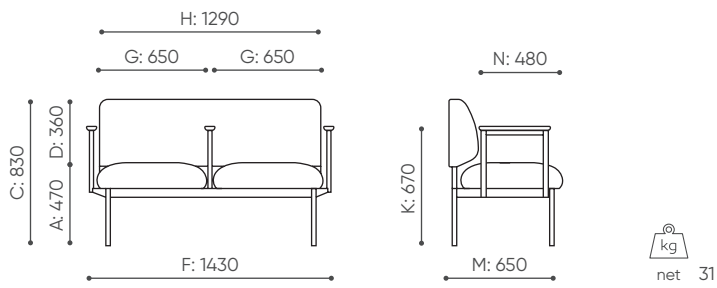

## FC S 423

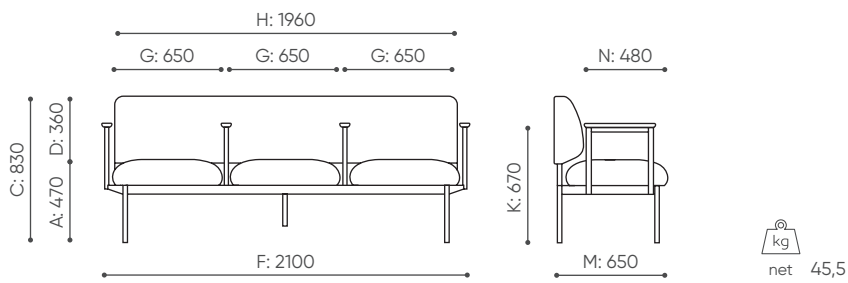

## FC SC 1 / FC SC 2 / FC SC 3

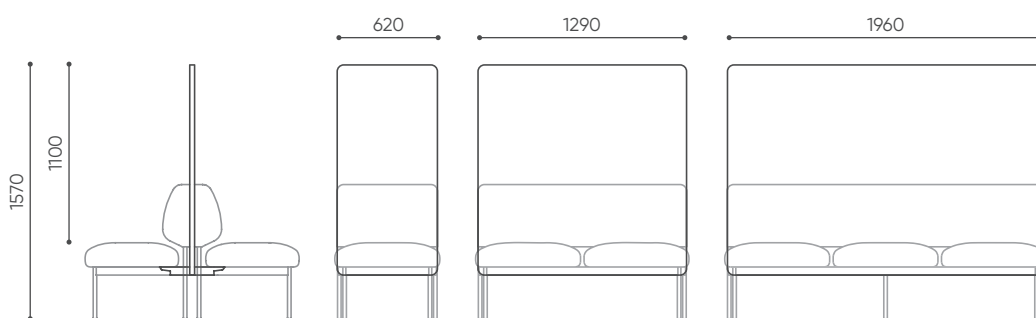

	SC1	SC2	SC3
H:	100	100	100
W:	640	1310	1980
L:	1170	1170	1170
kg net	SC1 10,5	SC2 25,5	SC3 31,5

FC L1

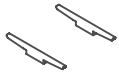

H: 50  
W: 50  
L: 400  
net  
1 kg

FC L1 A

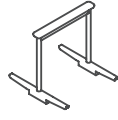

H: 50  
W: 50  
L: 400  
net  
2 kg

FC L1 SD



H: 40  
W: 400  
L: 400  
net  
2,5 kg

FC L1

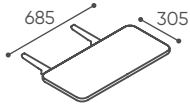

H: 40  
W: 650  
L: 305  
net  
4,5 kg

FC L1 A

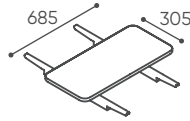

H: 40  
W: 730  
L: 305  
net  
3,5 kg

FC L1 SD

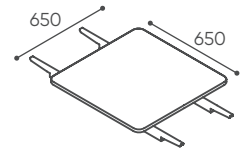

H: 40  
W: 650  
L: 1070  
net  
8 kg

FC L1

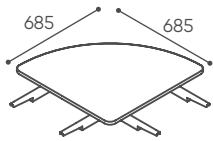

H: 70  
W: 710  
L: 710  
net  
7,5 kg

FC L1 A

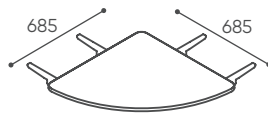

H: 70  
W: 710  
L: 710  
net  
7,5 kg

FR TB 65A

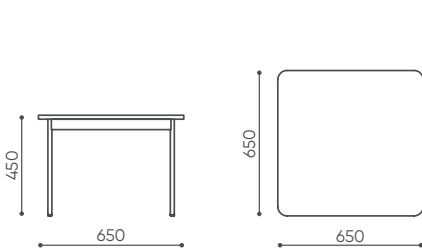

H: 400  
W: 810  
L: 810  
1 szt.  
St.  
pc.  
kg  
net 11  
brut 13

FR TB 80

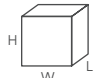
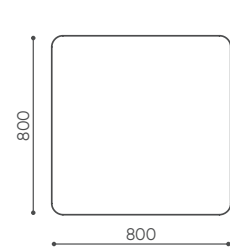
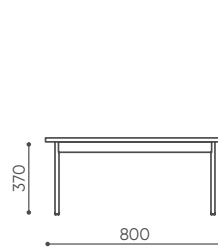

H: 400  
W: 810  
L: 810  
1 szt.  
St.  
pc.  
kg  
net 13,5  
brut 15,5

FR TB 65A

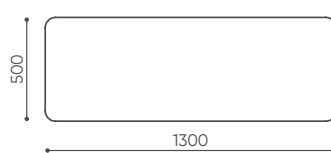
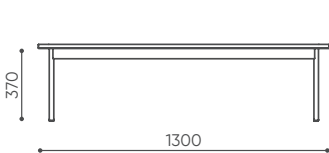

H: 430  
W: 510  
L: 1310  
1 szt.  
St.  
pc.  
kg  
net 15  
brut 17,5





**Bejot sp. z o. o.**

ul. Wybickiego 2A, Manieczki, 63-112 Brodnica n. Poznań, POLAND

[www.bejot.eu](http://www.bejot.eu)

édition 09/2024