

fora_care collection



bejot:



Kasper Mose

en:

Architect, furniture and interior designer. Graduated from Aarhus School of Architecture in 2008 at the Institute of Design. He gained experience at top Danish design offices: Arkitema and Friis & Moltke Architects. In 2020 he opened his own design studio, where he seeks simplicity and a holistic approach to design.

pl:

Architekt, projektant mebli i wnętrz. Ukończył Aarhus School of Architecture w 2008 roku w Instytucie Designu. Doświadczenie zdobywał w najlepszych duńskich biurach projektowych – Arkitema i Friis & Moltke Architects. W 2020 roku otworzył własne studio projektowe, w którym poszukuje prostoty i holistycznego podejścia do projektowania.

de:

Architekt, Möbel- und Innenarchitekt. Er schloss sein Studium an der Aarhus School of Architecture im Jahr 2008 am Institute of Design ab. Er sammelte Erfahrungen bei den führenden dänischen Designbüros: Arkitema und Friis & Moltke Architects. Im Jahr 2020 eröffnete er sein eigenes Designstudio, in dem er nach Einfachheit und einem ganzheitlichen Ansatz für das Design strebt.

**Kasper Mose's
designs is firmly
rooted in the
Danish design
tradition and
characterized
by simplicity,
functionality
and minimalism.**

be:durable
be:easycare
be:healthy
be:together
be:modular

bejot: of the world

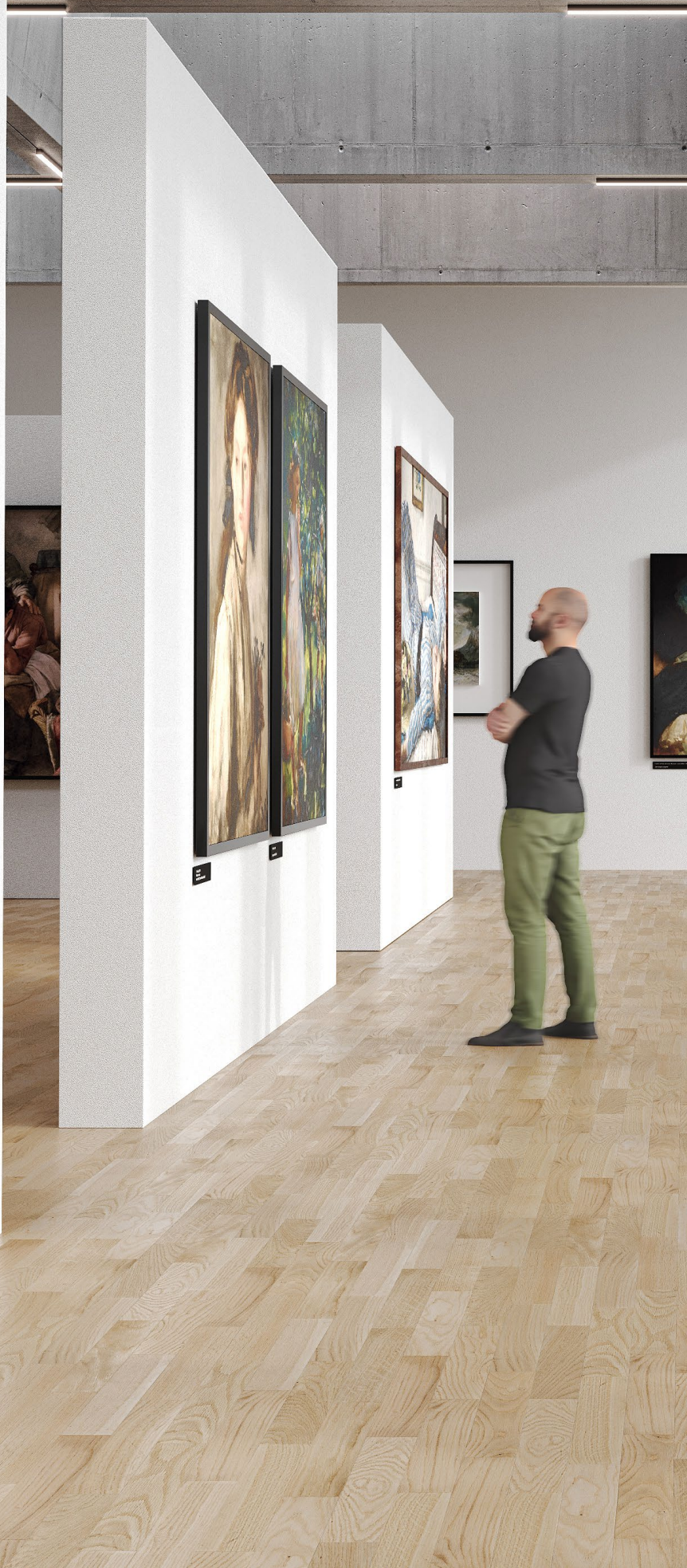

Fora_care FC S 423

Upholstered with Remix RX123

Metal finish RAL 9005 S



because
we:care

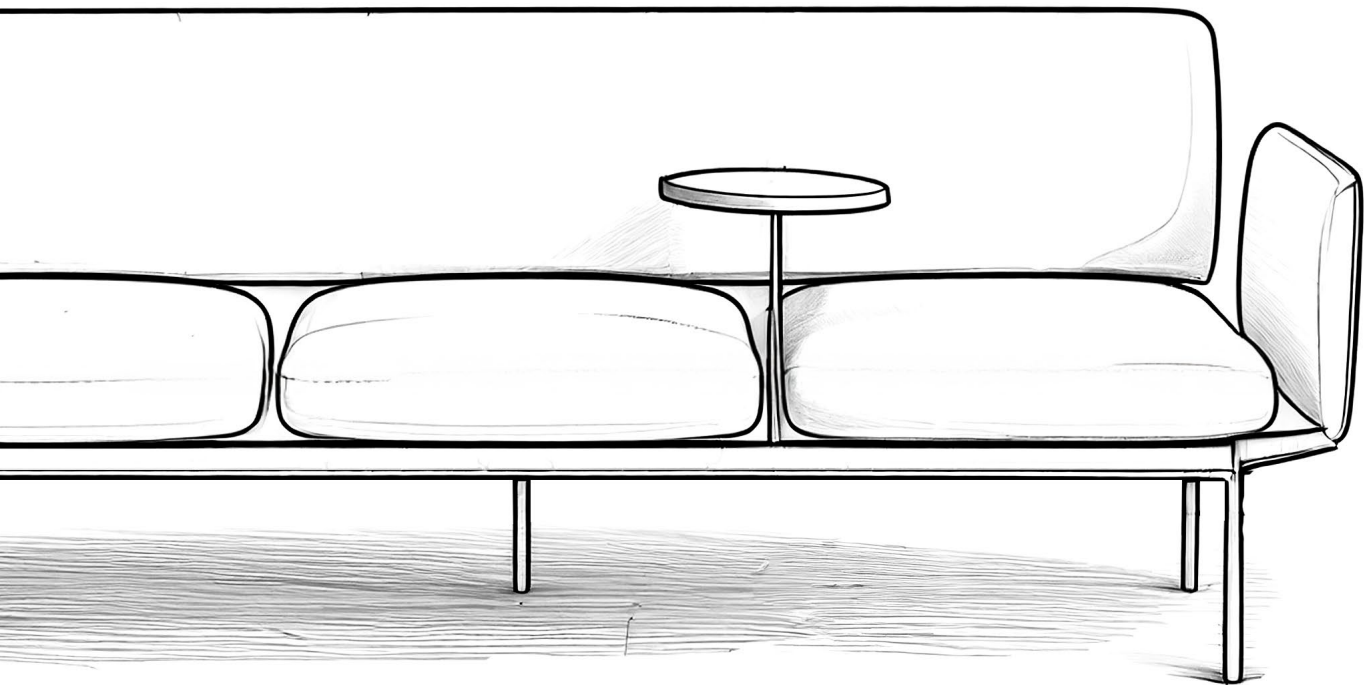

Created with care
of well:being and
simplicity of form

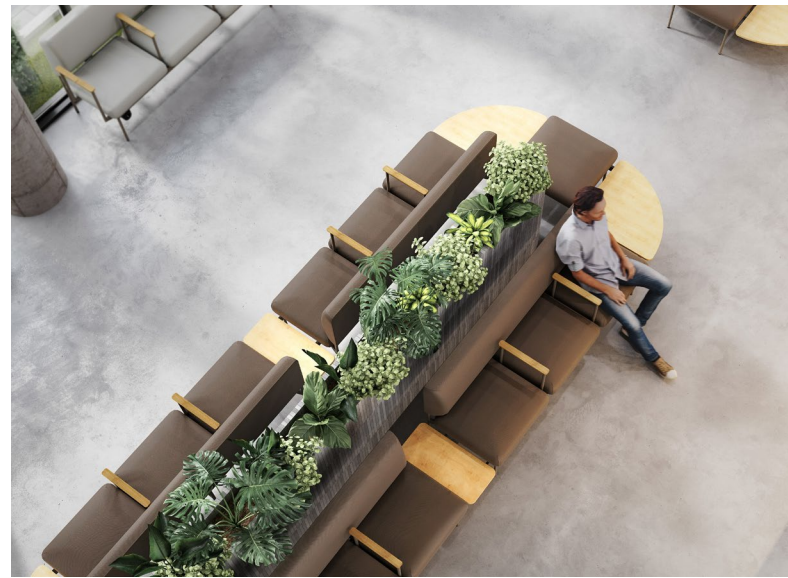

en:
we:care

We care about comfort, well:being and health. We have created a piece of furniture that will meet the expectations of the most demanding users. Comfortable and elegant, Fora_care will work well not only in offices, but also in public spaces, schools and medical facilities.

pl:
we:care

Zależy nam na wygodzie, dobrym samopoczuciu i zdrowiu. Stworzyliśmy mebel, który spełni oczekiwania najbardziej wymagających użytkowników. Wygodna i elegancka Fora_care sprawdzi się nie tylko w biurach, ale również w przestrzeniach publicznych, szkołach i placówkach medycznych.

de:
we:care

Komfort, Wohlbefinden und Gesundheit liegen uns am Herzen. Wir haben ein Möbelstück geschaffen, das die Erwartungen der anspruchsvollsten Nutzer erfüllt. Der bequeme und elegante Fora_care eignet sich nicht nur für Büros, sondern auch für öffentliche Räume, Schulen und medizinische Einrichtungen.





Fora_care sets
Upholstered with Cura CR157
Table top: U999
Metal finish RAL 9005 S



Fora_care sets

Upholstered with Cura CR157

Table top: U999

Metal finish RAL 9005 S

fora_care

soft seating collection



en:

Fora_care was created in the spirit of Danish design, which is characterised by a harmonious combination of aesthetics and usability. Its design is dominated by characteristic features such as minimalism, simplicity and functionality.

pl:

Fora_care została zaprojektowana w duchu duńskiego wzornictwa, które odznacza się harmonijnym połączeniem estetyki i użyteczności. W jej designie dominują charakterystyczne cechy takie jak minimalizm, prostota oraz funkcjonalność.

de:

Fora_care ist im Geiste des dänischen Designs gestaltet, das sich durch eine harmonische Verbindung von Ästhetik und Nutzen auszeichnet. Sein Design wird von charakteristischen Merkmalen wie Minimalismus, Einfachheit und Funktionalität dominiert.





be:modular

en:

Fora Care is a system of single, double and triple modular seating. The connectors and tops allow any configuration to be created. Two types of armrests: upholstered, metal with a wooden pad and a handy top mounted between the seats complete the collection.

pl:

Fora Care to system pojedynczych, dwu- i trzyosobowych modułowych siedzisk. Łączniki oraz blaty pozwalają na tworzenie dowolnych konfiguracji. Dwa rodzaje podłokietników: tapicerowane, metalowe z drewnianą nakładką oraz podręczny blat montowany między siedziskami dopełniają kolekcję.

de:

Fora Care ist ein System aus Einzel-, Doppel- und Dreifach-Sitzmodulen. Mit den Verbindungsstücken und Aufsätzen kann jede beliebige Konfiguration erstellt werden. Zwei Arten von Armlehnen: gepolstert, Metall mit Holzauflage und ein praktischer Aufsatz, der zwischen den Sitzen montiert wird, vervollständigen die Kollektion.



FC L2 TB E



FC L2 TB



FC LC TB IN



FC LC TB OUT



FC L3 TB



FC L1 SD



FC LI



FC LI A

en:

Free combination of modules

The combination of individual modules is made possible by special connectors. These allow individual configurations to be created, so that the layout can be adapted to more demanding spaces.

pl:

Dowolne łączenie modułów

Zestawianie ze sobą poszczególnych modułów możliwe jest dzięki specjalnym łącznikom. Pozwalają one tworzyć indywidualne konfiguracje i dostosowywać układ do bardziej wymagających przestrzeni.

de:

Freie Kombination von Modulen

Die Kombination der einzelnen Module wird durch spezielle Steckverbinder ermöglicht. Diese ermöglichen individuelle Konfigurationen, so dass das Layout auch an anspruchsvollere Räume angepasst werden kann.

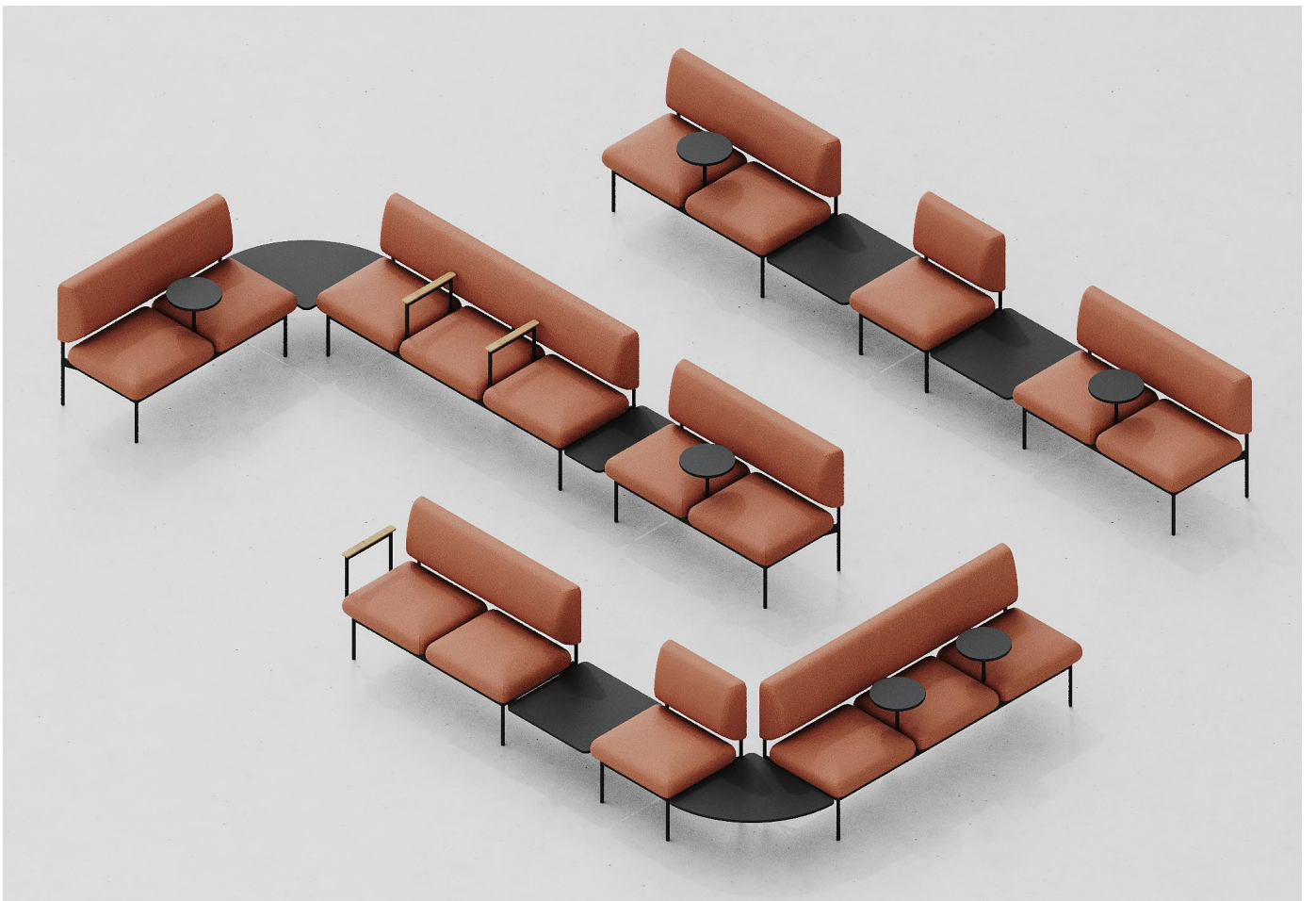
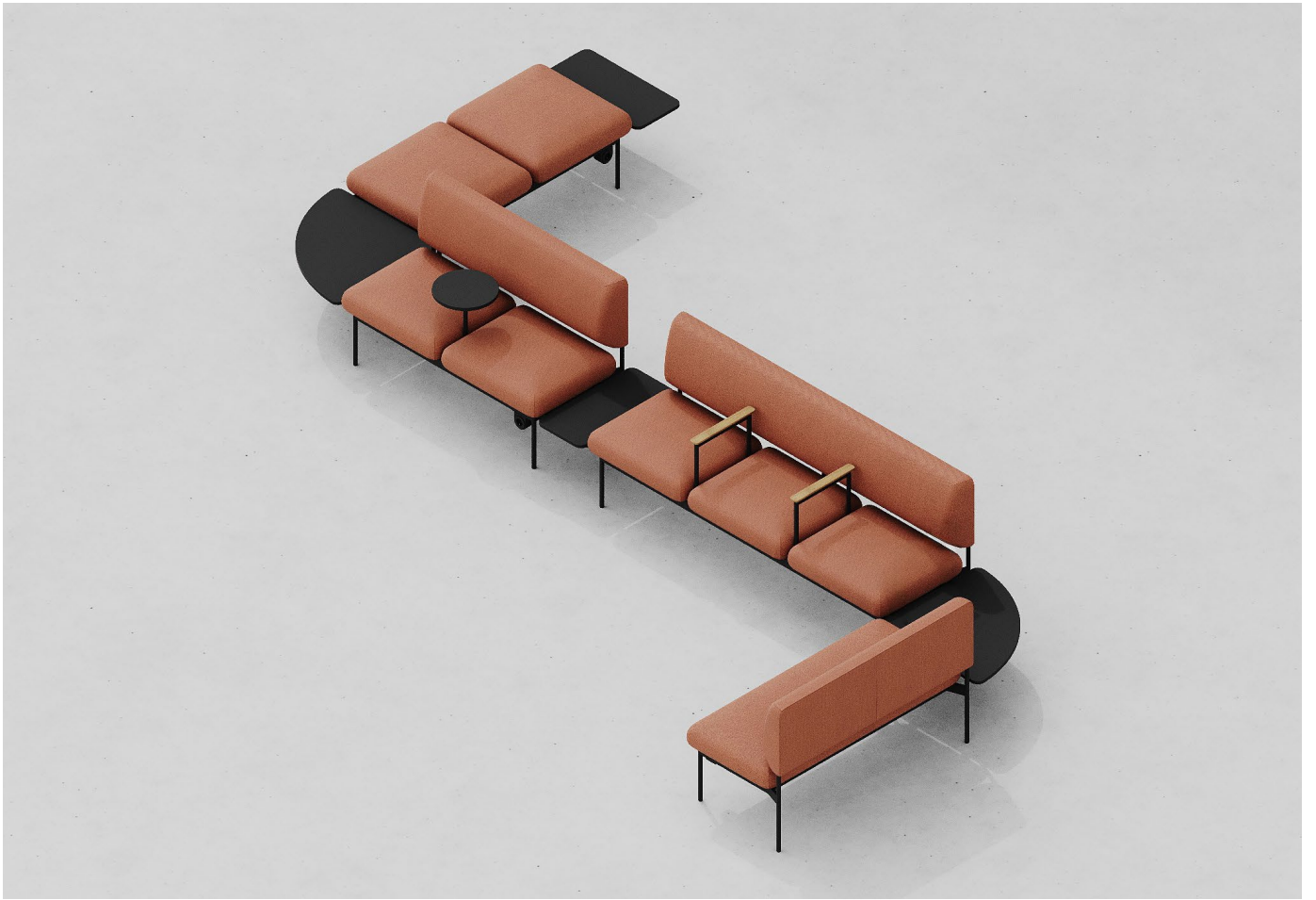



Fora_care set: 4 x FC S 403 + 2 x FC F 100 + 8 x FC A IN armrests + 4 x FC LC TB OUT+ 2 x FC L2 TB

Table top: laminate H3303 ST10

Metal finish: RALRAL 7039 M





en:

Comfortable armrests

Stable armrests make it easier to sit down and stand up, especially for people with restricted mobility. Placed between the seats, they further separate people sitting next to each other. Fora_care is a good solution for medical facilities and senior citizens' homes.

pl:

Wygodne podłokietniki

Stabilne podłokietniki ułatwiają siadanie i wstawanie, szczególnie osobom z ograniczeniami ruchowymi. Umieszczone pomiędzy siedziskami dodatkowo oddzielają siedzące obok siebie osoby. Fora_care jest dobrym rozwiązaniem dla placówek medycznych i domów seniora.

de:

Bequeme Armlehnen

Stabile Armlehnen erleichtern das Hinsetzen und Aufstehen, insbesondere für Menschen mit eingeschränkter Mobilität. Zwischen den Sitzen platziert, sorgen sie für eine weitere Trennung der nebeneinander sitzenden Personen.

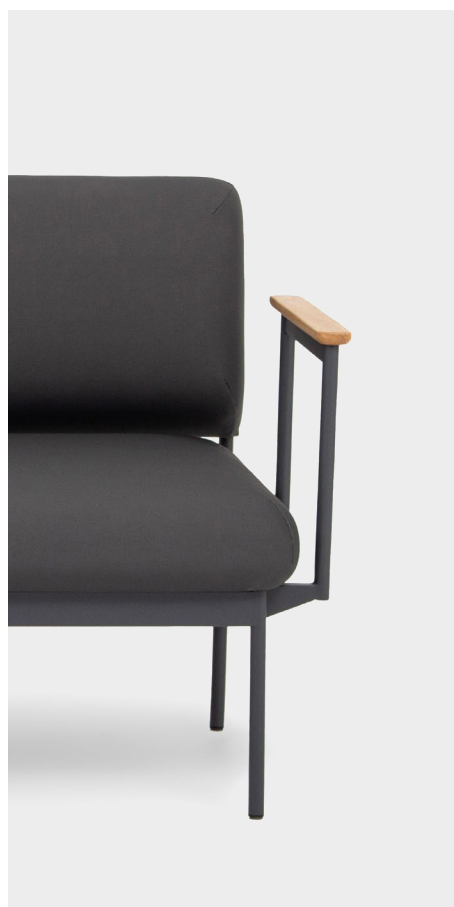
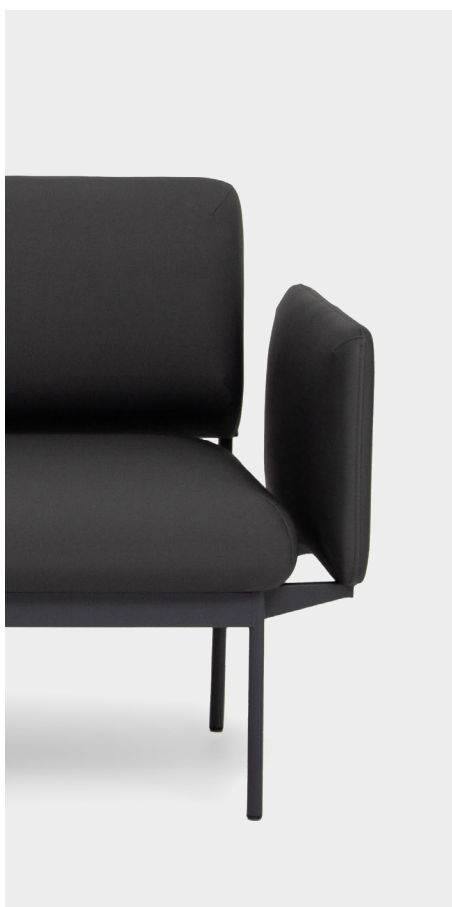
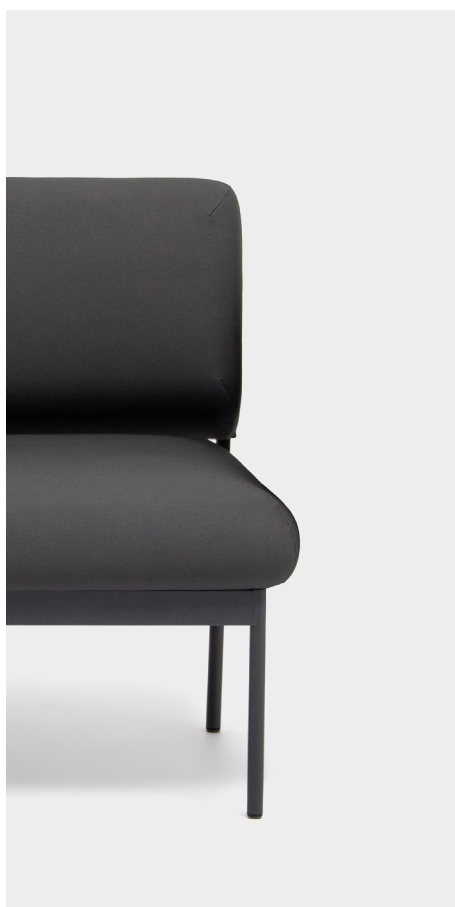

en: Armrest configurations: without armrest, upholstered armrest, metal armrest with wooden pad.

pl: Konfiguracje podłokietników: bez podłokietnika, podłokietnik tapicerowany, podłokietnik metalowy z drewnianą nakładką.

de: Armlehnenkonfigurationen: ohne Armlehne, gepolsterte Armlehne, Metallarmlehne mit Holzauflage.



Fora_care set: 4 x FC S 403 + 2 x FC F 100 + 8 x FC A IN armrests + 4 x FC LC TB OUT+ 2 x FC L2 TB



FC S 403 + 2 x FC A OUT + 2 x FC A IN
 Upholstered with Silvertex SV901
 Metal finish RAL 9005 S



Dermatologist
dr. Victoria Dema

Dermatological consultation
Dermatoscopy of skin lesions + consultation
Trichological consultation

Dr. Elena
Dr. Elena
Dr. Elena

Dr. Elena
Dr. Elena
Dr. Elena



Fora_care set
Upholstered with Silvertex SV298
Metal finish RAL 9005 S





en:

Rectangular and square coffee tables are an extension of the collection. Available in two top options: oak plywood or laminated board.

pl:

Rozszerzeniem kolekcji są prostokątne i kwadratowe stoliki kawowe. Dostępne w dwóch opcjach blatu: z klejonej dębowej lub płyty laminowanej.

de:

Klassiker und Design

Die rechteckigen und quadratischen Couchtische sind eine Erweiterung der Kollektion. Erhältlich in zwei Plattenvarianten: Eichen-Sperrholz oder laminierte Platte.

FR TB 130

Table top finger joint solid wood.
Metal finish RAL 9005 S.



FR TB 80

Laminated table top: finger joint wood
Metal finish RAL 9005 S

FR TB 65A

Laminated table top: finger joint wood
Metal finish RAL 9005 S

FR TB 130

Laminated table top: finger joint wood
Metal finish RAL 9005 S



Acoustic wall panels Flos:wall FS WRC 120 L
Upholstered with Blazer CUZ 1E

Table FR TB 65
Laminated tabletop U999
Metal finish RAL 9005 S

Sofa set FC S 412R + FC LC TB IN + FC S 200 + FC L2 TB E
Upholstered with Cura CR 157
Metal finish RAL 9005 S

be:reliable

en:

Optimal for the education sector

The larger space between the backrest and seat allows for easy access during cleaning. In addition, by using upholstery fabrics such as Silvertex, Valencia or Keimo, maintaining the cleanliness will not be a problem. The right choice of fabrics and a design that makes cleaning easy make Fora_care a good choice for dynamic and demanding learning environments.

pl:

Optymalna dla sektora edukacji

Większa przestrzeń między oparciem a siedziskiem pozwala na łatwy dostęp podczas czyszczenia. Dodatkowo, stosując tkaniny obiciowe takie jak Silvertex, Valencia czy Keimo, utrzymanie czystości nie sprawi problemu. Odpowiednio dobrane tkaniny oraz konstrukcja ułatwiająca czyszczenie sprawiają, że Fora_care jest dobrym wyborem do dynamicznych i wymagających środowisk edukacyjnych.

de:

Optimal für den Bildungsbereich

Der größere Abstand zwischen Rückenlehne und Sitz ermöglicht einen einfachen Zugang bei der Reinigung. Durch die Verwendung von Bezugstoffen wie Silvertex, Valencia oder Keimo ist die Sauberkeit kein Problem mehr. Die richtige Auswahl der Stoffe und ein Design, das die Reinigung erleichtert, machen Fora_care zu einer guten Wahl für dynamische und anspruchsvolle Lernumgebungen.





en:

Safety and stability.

Possibility of fixing the system Fora_care to the floor prevents the modules from moving and at the same time ensures a high degree of stability.

pl:

Bezpieczeństwo i stabilność

Możliwość mocowania systemu Fora_care do podłogi zapobiega przesuwaniu się modułów i jednocześnie zapewnia wysoką stabilność.

de:

Sicherheit und Stabilität

Möglichkeit, das System Fora_care am Boden verhindert ein Verrutschen der Module und gewährleistet gleichzeitig ein hohes Maß an Stabilität.





Fora care sets

Upholstered with Silvertex SV001 and SV661

be:intimate

space dividing acoustic walls



Sofa set FC SC 2 + 2xFC S 403

Upholstered with Fenno FN005

Metal finish RAL 9005 S

en:

Intimate spaces

Acoustic walls are part of the Fora_Care collection. They make it possible to create a cosy and quiet space. Such an arrangement can be used in restaurants or canteens. The acoustic partitions create an intimate space and additionally soundproof the room.

pl:

Kameralne przestrzenie

Częścią kolekcji Fora_Care są ścianki akustyczne. Pozwalają one wydzielić przytulną i wyciszoną przestrzeń. Taki układ znajdzie zastosowanie w restauracjach lub kantynach. Ścianki akustyczne stworzą kameralną przestrzeń i dodatkowo wygłusza pomieszczenie.

de:

Intime Räume.

Akustikwände sind Teil der Kollektion Fora_Care. Sie ermöglichen es, einen gemütlichen und ruhigen Raum zu schaffen. Eine solche Einrichtung kann in Restaurants oder Kantinen verwendet werden. Die akustischen Trennwände schaffen einen intimen Raum und dämmen den Raum zusätzlich ein.



Table FC TB L 19

Tabletop: finger joint wood KDAB
Metal finish RAL 9005 S

Sofa set FC SC 2 + 2x FC S 403

Upholstered with Blazer CUZ 2Q
Metal finish RAL 9005 S



FC TB 130S



FC TB 130L



FC TB 200S



FC TB 200L



FC TB 63S



FC TB 70S

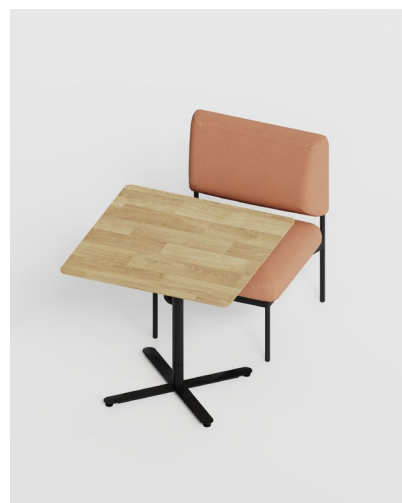

FC TB 80L

en:

High tables from the Fora_care collection are recommended for cafes, restaurants, or canteens. They come in seven models, each with different dimensions and construction.

pl:

Dla kawiarni, restauracji lub kantyn warto wybrać wysokie stoły, które stanowią uzupełnienie kolekcji Fora_care. Dostępne są w siedmiu modelach, różniących się wymiarami oraz konstrukcją.

de:

Die Stehtische der Kollektion Fora_care werden für Cafés, Restaurants oder Kantinen empfohlen. Sie sind in sieben Modellen erhältlich, die sich in Größe und Konstruktion unterscheiden.



Sofa set FC SC 3 + 2x FC S 423
Upholstered with Blazer CUZ 47
Metal finish RAL 9005 S

Sofa FC S 423
Upholstered with Blazer CUZ 47
Metal finish RAL 9005 S

Saar sets
Laminated shelves U999
Metal finish RAL 9005 S

Table FC TB L 19
Tabletop: finger joint wood KDAB
Metal finish RAL 9005 S

be:useful

the secret inside the cross-section



en:

Versatility and comfort

Fora_care is a versatile piece of furniture. The simple metal base provides the basis for many seat, armrest and connector variants. It is also possible to replace the upholstery yourself in the event of heavy soiling or a change in interior design.

pl:

Uniwersalność i wygoda

Fora_care to mebel uniwersalny. Prosta metalowa baza stanowi podstawę dla wielu wariantów siedzisk, podłokietników i łączników. Istnieje również możliwość samodzielnej wymiany tapicerki w przypadku silnych zabrudzeń lub zmiany wystroju wnętrza.

de:

Komfort und Bequemlichkeit

Fora_care ist ein vielseitiges Möbelstück. Das schlichte Metallgestell bildet die Basis für viele Sitz-, Armlehnen- und Verbindungsvarianten. Es ist auch möglich, die Polsterung bei starker Verschmutzung oder einer Änderung der Inneneinrichtung selbst auszutauschen.



en:

Environmentally responsible

The collection has been designed to reduce the harmful impact on the environment. We do not use metal staples in the production of *Fory_care*, which allows the upholstery to be easily replaced and the product can be easily taken apart after its lifetime.

pl:

Odpowiedzialni ekologicznie

Kolekcja została zaprojektowana tak, aby ograniczyć szkodliwy wpływ na środowisko. Przy produkcji *Fory_care* nie używamy metalowych zszywek, co pozwala na łatwą wymianę tapicerki, a po okresie eksploatacji produkt można łatwo rozdzielić na części.

de:

Ökologisch verantwortlich

Die Kollektion wurde entwickelt, um die schädlichen Auswirkungen auf die Umwelt zu reduzieren. Bei der Herstellung von *Fory_care* werden keine Metallklammern verwendet, so dass die Polsterung leicht ausgetauscht werden kann und das Produkt nach einer gewissen Zeit des Gebrauchs einfach auseinandergenommen werden kann.



J.M.W. Turner
Rain, Steam, and Great Railway Bridge
1844

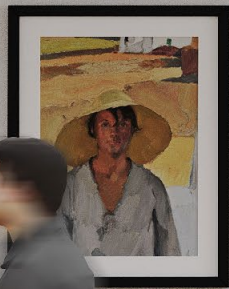

Raphael
The Virgin and Child with the Coward
1505





Fora care set 4 x FC F 403+ 4 x FC LC TB OUT
Upholstered with Remix RX123
Laminated tabletop U999
Metal finish RAL 9005 S



Fora care set

Upholstered with Remix RX452
Laminated tabletop U999
Metal finish RAL 9005 S

Table FR TB 130

Laminated tabletop U999
Metal finish RAL 9005 S

be:recharged

possibilities for positioning mediaports



en:
Mediaports

The installation of mediaports provides convenient access to power sources, allowing the use of electronic devices without the need to interrupt relaxation or search for sockets. This allows users to comfortably use their devices in a convenient location.

pl:
Mediaporty

Montaż mediaportów zapewnia wygodny dostęp do źródeł zasilania, umożliwiając korzystanie z urządzeń elektronicznych bez potrzeby przerywania relaksu czy szukania gniazdek. Dzięki temu użytkownicy mogą komfortowo używać swoich urządzeń w dogodnym miejscu.

de:
Mediaports

Die Installation von Mediaports ermöglicht einen bequemen Zugang zu Stromquellen, so dass elektronische Geräte genutzt werden können, ohne dass die Entspannung unterbrochen oder nach Steckdosen gesucht werden muss. So können die Nutzer ihre Geräte bequem an einem geeigneten Ort nutzen.

Fora_care sofas & modules

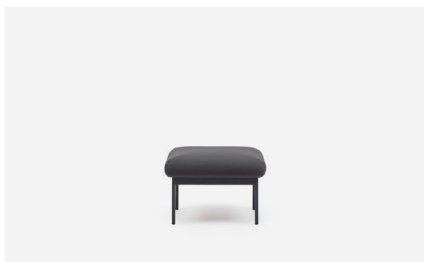

FC F 100

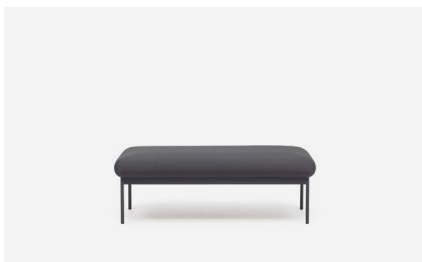

FC F 200



FC F 300



FC F 401



FC F 402



FC F 403



FC F 412L



FC F 422



FC F 423

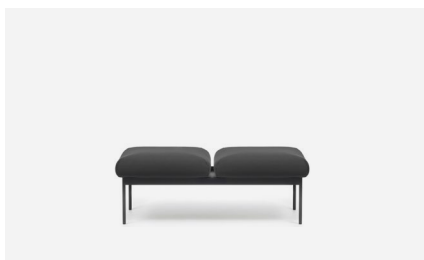

FC S 200



FC S 402



FC S 422



FC S 300



FC S 403



FC S 423

L - armrest on the left side of the sitting person
R - armrest on the right side of the sitting person

L - armrest on the left side of the sitting person
R - armrest on the right side of the sitting person

L- Armlehne auf der linken Seite einer sitzenden Person
R - Armlehne rechts von der sitzenden Person

Powder-coated armrest mounted on the edge of the sofa or between the seats (in the colour of the structure + wood overlay natural oak)



FC S 402 + 2 x FC A OUT + FC A IN



FC F 402 + 2 x FC A OUT



FC S 403 + 2 x FC A OUT + 2 x FC A IN

Technical data

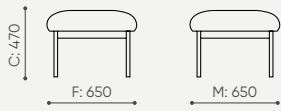

FC F 100

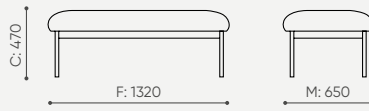

FC F 200

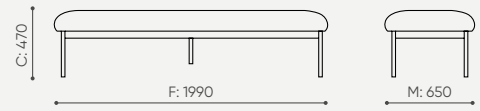

FC F 300

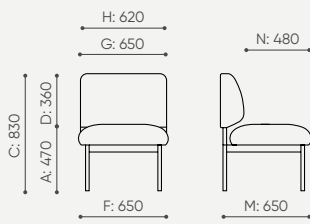

FC F 401

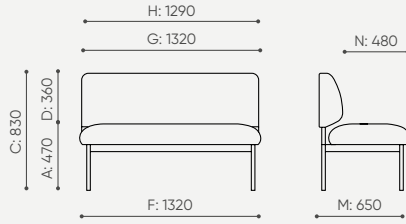

FC F 402

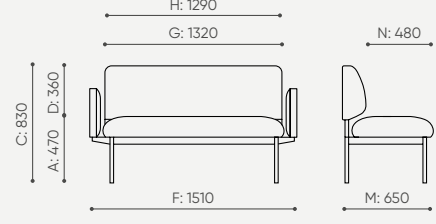

FC F 422

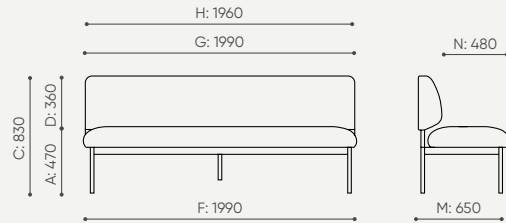

FC F 403

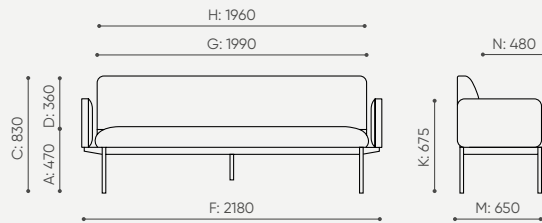

FC F 423

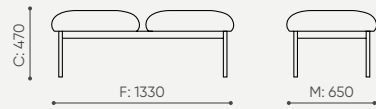

FC S 200

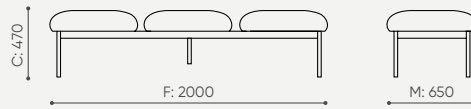

FC S 300

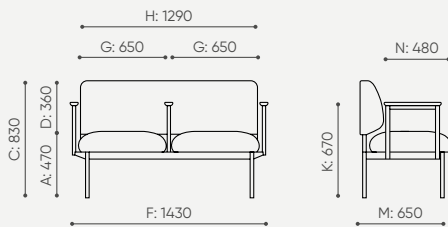

FC S 402 + 2 x FC A OUT + FC A IN

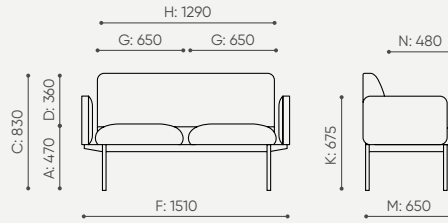

FC S 422

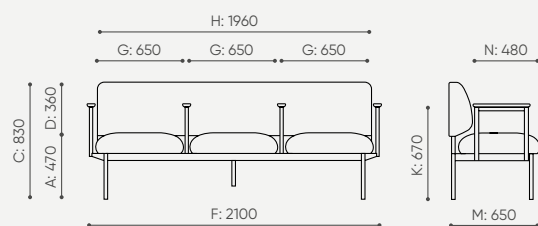

FC S 403 + 2 x FC A OUT + 2 x FC A IN

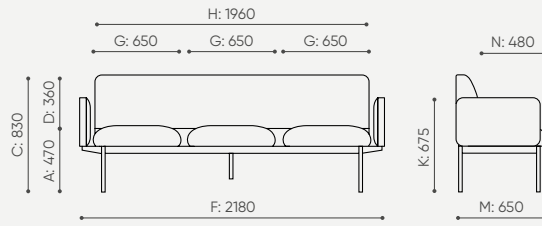

FC S 423

Fora_care elements



FC L1



FC LI A



FC LI SD



FC L2 TB E



FC L2 TB



FC L3 TB

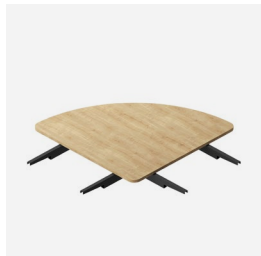

FC LC TB IN



FC LC TB OUT

Fora_care tables

High: 740 mm



FC TB 200L (tabletop: 800x1950 mm)



FC TB 200S (tabletop: 700x1950mm)

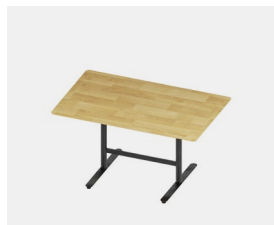

FC TB L 130L (tabletop: 800x1280mm)

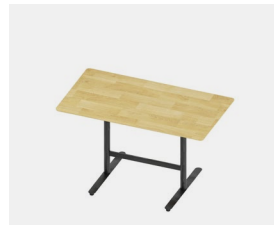

FC TB L 130S (tabletop: 700x1280mm)

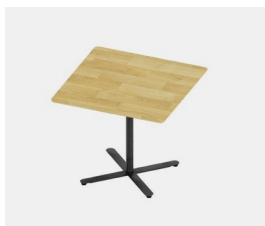

FC TB 80L (tabletop: 800x800mm)

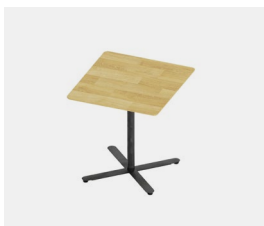

FC TB 70S (tabletop: 700x700mm)

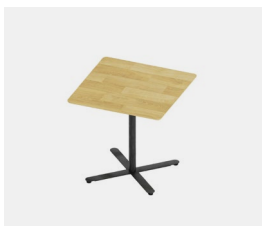

FC TB 63S (tabletop: 630x700mm)

Fora_care coffe tables



FR TB 65A (h=450 mm)

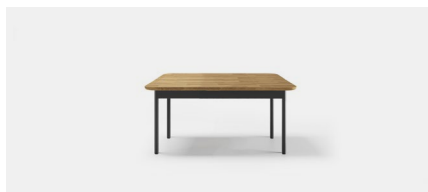

FR TB 80 (h=370 mm)

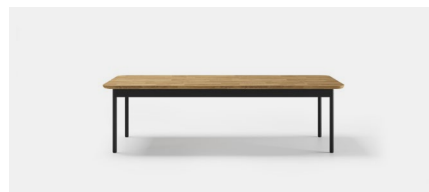

FR TB 130 (h=370 mm)

en:

Milled top

Milled top available only for the finger joint solid wood version.

pl:

Frezowany blat

Frezowany blat dostępny tylko dla wersji z klejonki dębowej.

de:

Die gefräste Platte

Die gefräste Platte ist nur für die Version aus brett-schichtholz Eiche erhältlich.



KDAB

Milled tabletop / Frezowany blat / Gefräste Platte *

Technical data

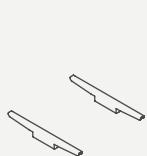

FC L1

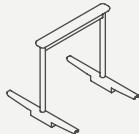

FC L1A

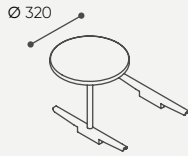

FC L1 SD

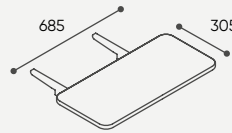

FC L2 TB E

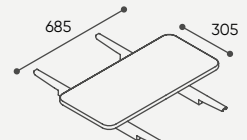

FC L2 TB

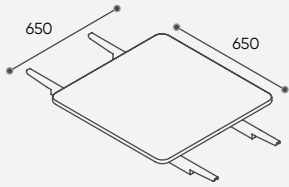

FC L3 TB

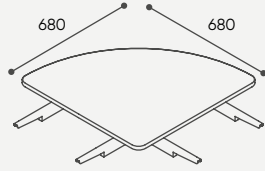

FC LC TB IN

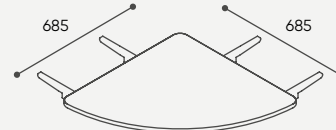

FC LC TB OUT

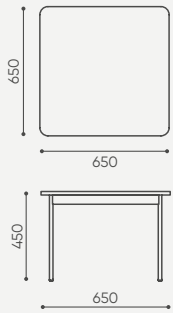

FR TB 65A

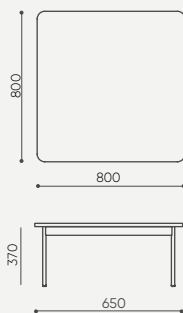

FR TB 65

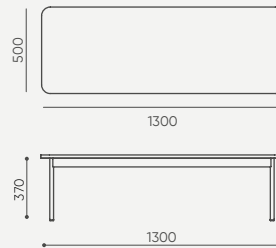

FR TB 13

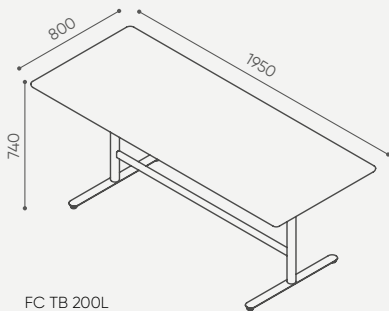

FC TB 200L

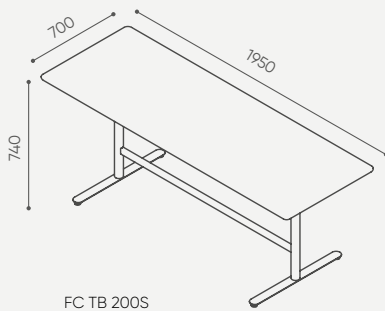

FC TB 200S

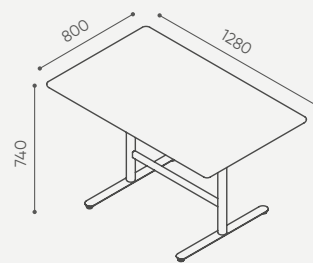

FC TB 130L

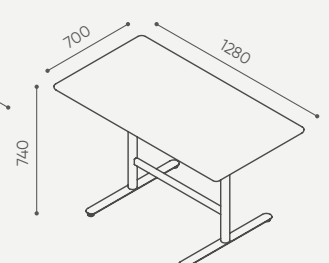

FC TB 130S

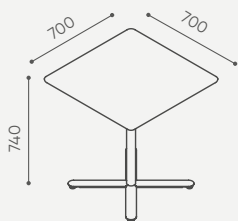

FC TB 70S

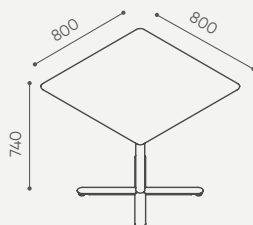

FC TB 80L

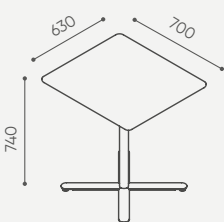

FC TB 63S



Fora_care sofas & modules

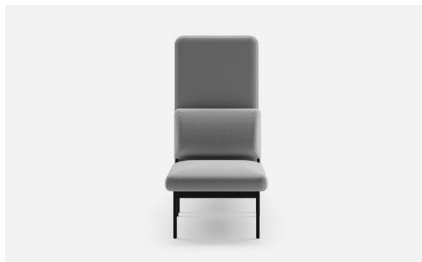

FC F 401 + FC SC 1



FC F 402 + FC SC 2



FC F 403 + FC SC 3



Back walls (only available between 2 sofas with backrests)
Ścianki tylne (dostępne tylko między 2 sofami z oparciami)
Rückwände (nur zwischen 2 Sofas mit Rückenlehnen)

en:

Mediports

Mediports can be mounted under the seat:
Mediport round PIX (black-B) - 1 x 230 V
voltage socket
Mediport round PIX (black-B) - 2 x USB
charger

pl:

Mediporty

Mediporty mogą być zamontowane pod
siedziskiem:
Mediport okrągły PIX (czarny-B) - 1 gniaz-
do napięciowe 230 V
Mediport okrągły PIX (czarny-B) - 2 x
ładowarka

de:

Mediports

Mediports können unter dem Sitz mon-
tiert werden:
Mediport rund PIX (schwarz-B) - 1
Spannungssteckdose 230 V
Mediport rund PIX (schwarz-B) - 2 x
USB-Ladegerät

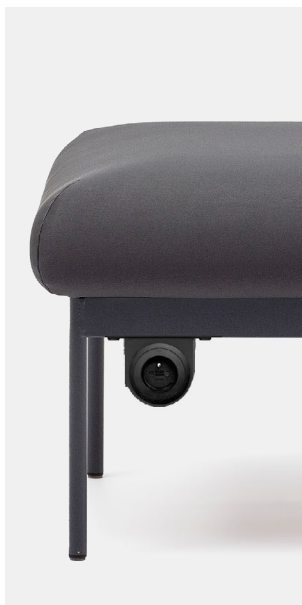

MEDIAPORT



The steel profile and brackets allow for an aesthetically pleasing cable routing.
Stalowy profil i uchwyty pozwalają na estetyczne poprowadzenie przewodu.
Das Stahlprofil und die Halterungen ermöglichen eine ästhetisch ansprechende Kabelführung.

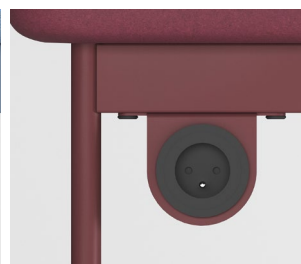
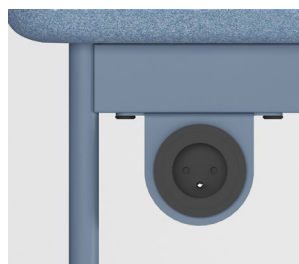
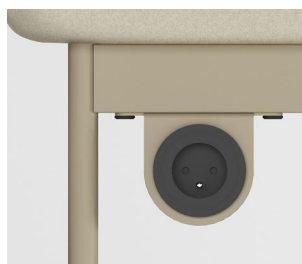

The mediport housing can be made in the colour
of the structure.
Możliwość wykonania obudowy mediportu
w kolorze konstrukcji.
Das Mediport-Gehäuse kann in der Farbe
der Struktur hergestellt werden.

Technical data

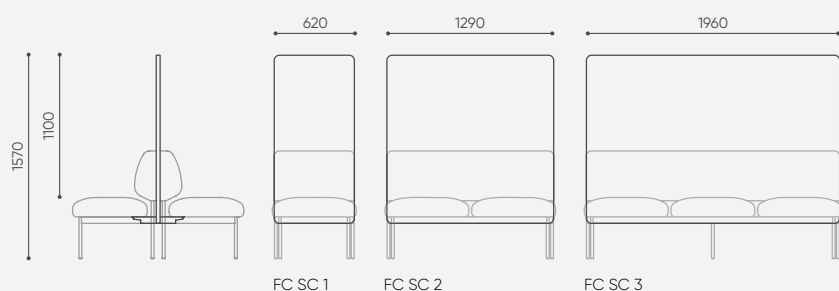

en:

Possibilities of placing mediaports:

FCF 100, FCF 401 - max. 1 mediaport
 FCF 200, FCS 200, FCF 300, FCS 300, FCF
 4X2, FCF 4X3, FCS 4X2, FCS 4X3 - max. 2
 mediaports

pl:

Możliwość rozmieszczenia mediaportów:

FCF 100, FCF 401- max. 1 mediaport
 FCF 200, FCS 200, FCF 300, FCS 300, FCF
 4X2, FCF 4X3, FCS 4X2, FCS 4X3
 max. 2 mediaporty

de:

**Möglichkeit der Anordnung von Medi-
aports:**

FCF 200, FCS 200, FCF 300, FCS 300,
 FCF 4X2, FCF 4X3, FCS 4X2, FCS 4X3
 Max. 2 Mediaports
 FCF 100, FCF 401
 Max. 1 Mediaport

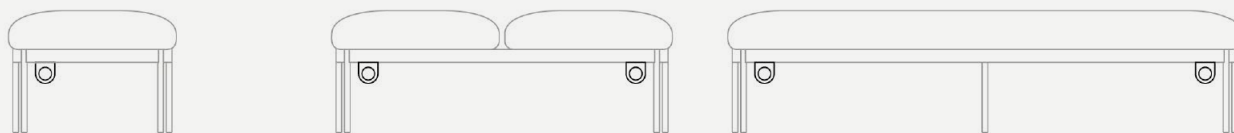

en:

Dimensions and weights are approximate
 and may vary by 5%. The data is given for
 the basic configuration of products. The re-
 quire-ments of the standard are always met.

pl:

Wymiary i wagi mają charakter orientacyjny
 i mogą się różnić o 5%. Dane podane są do
 podstawowych konfiguracji produktów.
 Zawsze spełnione są wymogi normy.

de:

Abmessungen und Gewichte sind ungefähr und
 können um 5% variieren. Die Daten sind für die
 Grundkonfiguration von Produkten angegeben.
 Die Anforderungen der Norm werden immer erfüllt.



Fora care set: FC F 200 + FC L2 TB + FC F 100

Upholstered with Cura CR012

Laminated tabletop U999

Metal finish RAL 9005 S



be:sustainable

product life-cycle management



en:

Bejot's synonyms for sustainability are: environmentally conscious action, safe products, and the organization of ergonomic areas for working and interacting, affecting the creativity and well-being of employees. No metal staples are used in the production of Fora_care collection, and the fabric is not glued to the foam. As a result, the product can be easily separated into individual parts after a lifetime - up to 98% of the furniture is recyclable. We also provide a 5-year warranty and post-warranty service, and introduce the principle of minimizing waste after the product's life cycle.

pl:

Synonimami zrównoważonego rozwoju Bejot są: świadome działanie w sposób przyjazny dla środowiska, bezpieczne produkty oraz organizacja ergonomicznych stref do pracy i współdziałania, wpływających na kreatywność i samopoczucie pracowników. Przy produkcji kolekcji Fora_care nie używamy metalowych zszywek, a tkanina nie jest przyklejana do pianki. Dzięki temu po okresie eksploatacji produkt można łatwo rozdzielić na poszczególne części - aż 98% mebla nadaje się do ponownego przetworzenia. Zapewniamy również 5 lat gwarancji i serwis pogwarancyjny, a także wprowadzamy zasadę minimalizacji odpadów po zakończonym cyklu życia produktu.

de:

Die Synonyme für Nachhaltigkeit bei Bejot sind: bewusstes umweltfreundliches Handeln, sichere Produkte und die Einrichtung ergonomischer Arbeits- und Interaktionsbereiche, die sich auf die Kreativität und das Wohlbefinden der Mitarbeiter auswirken. Bei der Herstellung der Fora_care-Kollektion werden keine Metallklammern verwendet und der Stoff ist nicht mit dem Schaumstoff verklebt. Dadurch kann das Produkt nach seiner Lebensdauer leicht in seine Einzelteile zerlegt werden - bis zu 98 % der Möbel sind recycelbar. Außerdem bieten wir eine 5-Jahres-Garantie und einen Nachgarantieservice und führen das Prinzip der Abfallminimierung am Ende des Lebenszyklus des Produkts ein.

Fora_care collection – ecology and recycling

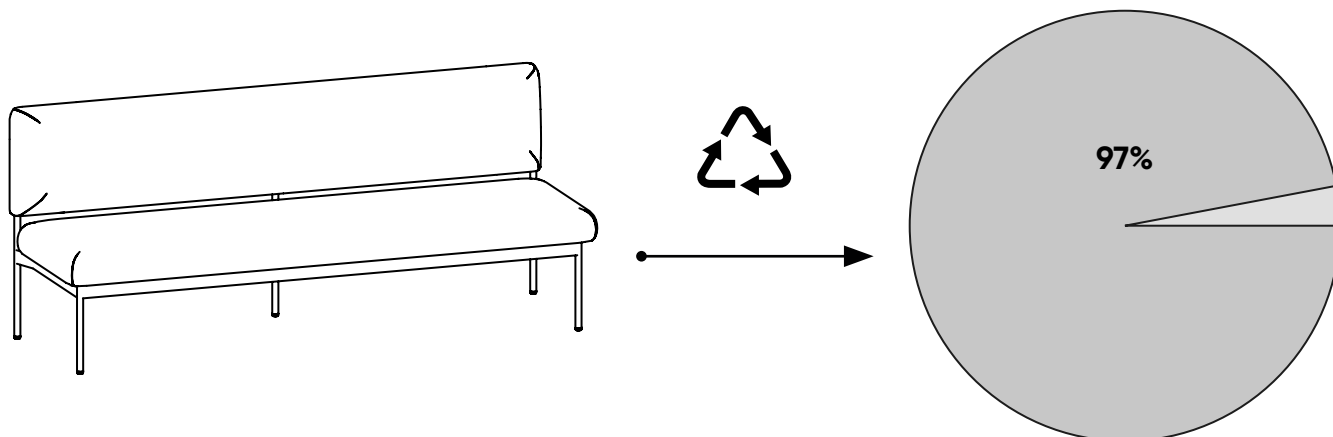

en:

We care about the environment

We use recyclable materials, e.g. in the sample Fora_care FCS 403 presented above, we can reuse as much as 97% of the initial materials.

pl:

Dbamy o środowisko

Używamy materiałów podlegających recyklingowi, np. w powyższym przykładowym modelu Fora_care FCS 403 możemy wykorzystać ponownie aż 97% mebla.

de:

Wir Schützen unsere Umwelt

Wir verwenden wiederverwertbare Materialien, wie z.B. bei den Fora_care FCS 403 oben, können wir bis zu 97% des Möbelstücks wiederverwenden.



wood / drewno / Holz

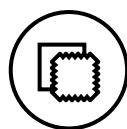
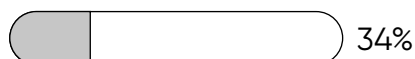

upholstery / tapicerka / Polster

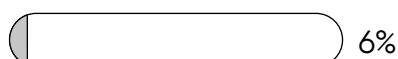

steel / stal / Stahl

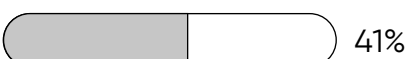

plastic / plastik / Plastik

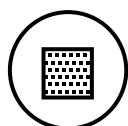

foam / pianka / Schaum

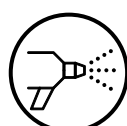
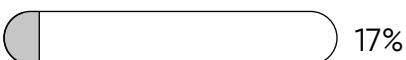

powder paint/farba proszkowa / Pulverfarbe

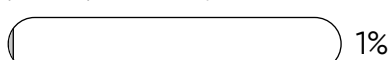

en:

Material composition

Percentage share of the weight of a given raw material on the example of Fora_care FCS 403.

pl:

Skład materiałowy

Procentowy udział masy danego surowca w przykładowym modelu Fora_care FCS 403.

de:

Materialzusammensetzung

Prozentualer Gewichtsanteil eines bestimmten Rohstoffs im beispielhaften Fora_care FCS 403.

Bejot sp. z o.o.

Wybickiego 2A, Manieczki, 63-112 Brodnica n. Poznań, POLAND

tel.: +48 (61) 281 22 25

www.bejot.eu