

woodbe

WB 870

: fiche produit



Les chaises, les hockers et les bancs en chêne massif dotés d'un siège rembourré. La collection Woodbe combine le minimalisme, la fonctionnalité et l'amour pour les matériaux naturels.

La structure des meubles est composée de formes géométriques simples et originales, avec un patin caractéristique au niveau de la base.

design:

Włodzimierz Orsztynowicz

Site du produit
[lien vers le site](#)



bejot:

dimensions

WB 870

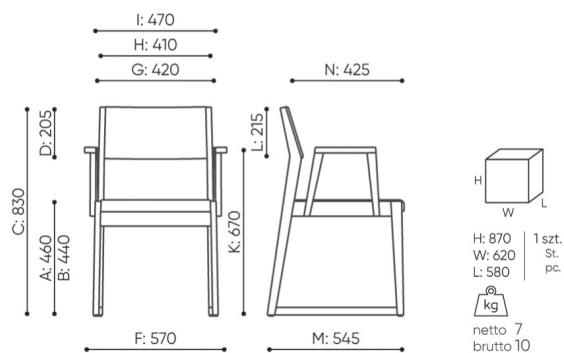

WB 870

- A seat height: overall dimensions
- B seat height: measured according to the norm
PN EN 1335 - 1
- C chair height
- D backrest height
- E headrest height
- F dimensional width chair / base
- G seat width
- H backrest width
- I width between armrests
- K height from the floor to the armrest
- L backrest length
- M dimensional chair depth
- N seat depth / seat length

Dimensions are approximate and may vary depending on the selected product configuration. The requirements of the standard are always met.

mat riaux disponibles pour la collection

1st price group	Bond, Keimo, Sawana
2nd price group	Alpa, Charles, Charles - Studio Design, Cura, Pastel, Roccia, Valencia
3rd price group	Ally, Ally SD, Alpa-Studio Design, Blazer, Cura SD, Easy SD, Oceanic, Silvertex , Silvertex - Studio Design, Synergy, Synergy - Studio Design, Valencia - Studio Design
4th price group	Heritage, Oceanic-Studio Design, Remix - Studio Design
5th price group	Steelcut Trio 3
Cuir	Leather
Wood	Solid oak wood - clear varnish matt

bejot:woodbe

