

wei

WE 715

: fiche produit



Grâce à son design unique et à des matériaux de haute qualité, cette chaise est intemporelle et polyvalente. Elle est idéale pour tout type d'intérieur, comme un restaurant, une salle de conférence ou une salle à manger.

Le concept est basé sur le thème de la nature. La simplicité et la robustesse sont combinées pour créer une chaise monolithique, très pratique, confortable et légère, mais aussi durable.

design:
Henrik Schultz

Site du produit
[lien vers le site](#)



bejot:

dimensions

WE 715

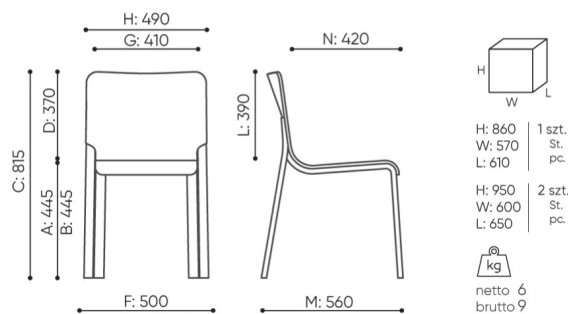

WE 715 1N

- A seat height: overall dimensions
- B seat height: measured according to the norm
PN EN 1335 - 1
- C chair height
- D backrest height
- E headrest height
- F dimensional width chair / base
- G seat width
- H backrest width
- I width between armrests
- K height from the floor to the armrest
- L backrest length
- M dimensional chair depth
- N seat depth / seat length

Dimensions are approximate and may vary depending on the selected product configuration. The requirements of the standard are always met.

mat riaux disponibles pour la collection

1st price group	Bond, Fenno, Keimo, Sawana
2nd price group	Alpa, Charles, Charles - Studio Design, Cura, Pastel, Roccia, Valencia
3rd price group	Ally, Ally SD, Alpa-Studio Design, Blazer, Cura SD, Easy SD, Oceanic, Silvertex , Silvertex - Studio Design, Synergy, Synergy - Studio Design, Valencia - Studio Design
4th price group	Heritage, Oceanic-Studio Design, Remix - Studio Design
5th price group	Accessoire, Steelcut Trio 3
Cuir	Leather
Natural oak veneer	Natural oak veneer
Metal	Metal - powder coated

bejot:wei

