

wei

WE 270

: fiche produit



Grâce à son design unique et à des matériaux de haute qualité, cette chaise est intemporelle et polyvalente. Elle est idéale pour tout type d'intérieur, comme un restaurant, une salle de conférence ou une salle à manger.

Le concept est basé sur le thème de la nature. La simplicité et la robustesse sont combinées pour créer une chaise monolithique, très pratique, confortable et légère, mais aussi durable.

design:
Henrik Schultz

Site du produit
[lien vers le site](#)

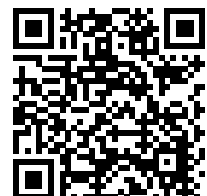

bejot:

dimensions

WE 270

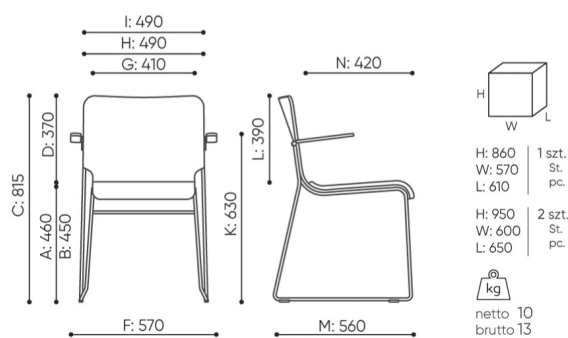

WE 270 2N

- A seat height: overall dimensions
- B seat height: measured according to the norm
PN EN 1335 - 1
- C chair height
- D backrest height
- E headrest height
- F dimensional width chair / base
- G seat width
- H backrest width
- I width between armrests
- K height from the floor to the armrest
- L backrest length
- M dimensional chair depth
- N seat depth / seat length

Dimensions are approximate and may vary depending on the selected product configuration. The requirements of the standard are always met.

mat riaux disponibles pour la collection

| | |
|--------------------|---|
| 1st price group | Bond, Fenno, Keimo, Sawana |
| 2nd price group | Alaska, Alpa, Charles, Charles - Studio Design, Cura, Pastel, Roccia, Valencia |
| 3rd price group | Ally, Ally SD, Alpa-Studio Design, Blazer, Cura SD, Easy SD, Oceanic, Silvertex , Silvertex - Studio Design, Synergy, Synergy - Studio Design, Valencia - Studio Design |
| 4th price group | Heritage, Oceanic-Studio Design, Remix - Studio Design |
| 5th price group | Accessoire, Steelcut Trio 3 |
| Cuir | Leather |
| Natural oak veneer | Natural oak veneer |
| Metal | Metal - powder coated |

bejot:wei

