

# point

POP 1200

: fiche produit



Point est une collection de poufs ronds qui peuvent être utilisés comme des sièges supplémentaires non officiels. Ils sont parfaits pour les zones de repos dans les bureaux, les musées, les bibliothèques et autres lieux publics.

**design:**  
**Bejot Development Team**

**Site du produit**  
[lien vers le site](#)



# bejot:

# dimensions

POP 1200

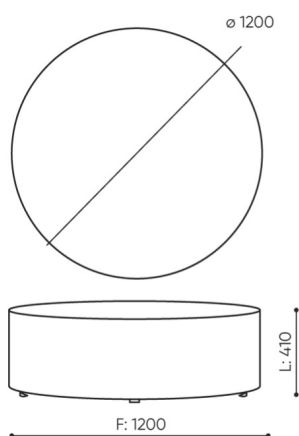

H: 440  
W: 1230  
L: 1230

1 szt.  
St.  
pc.



netto 30  
brutto 34

POP 1200

- A seat height: overall dimensions
- B seat height
- C chair height: overall dimensions
- D backrest height
- F chair width: overall dimensions
- G seat width
- H backrest width
- K height from the floor to the armrest
- M chair depth: overall dimensions
- N seat depth / seat length

Dimensions are approximate and may vary depending on the selected product configuration. The requirements of the standard are always met.

## mat riaux disponibles pour la collection

1st price group	Bond, Fenno, Keimo, Sawana
2nd price group	Alpa, Charles, Charles - Studio Design, Cura, Era - Studio Design, Pastel, Roccia, Valencia
3rd price group	Ally, Ally SD, Alpa-Studio Design, Blazer, Cura SD, Easy SD, Oceanic, Rhythm, Silvertex , Silvertex - Studio Design, Synergy, Synergy - Studio Design, Valencia - Studio Design
4th price group	Heritage, Oceanic-Studio Design, Remix - Studio Design
5th price group	Accessoire, Steelcut Trio 3
Cuir	Leather

