

point

POP 900

: product card



Point is a collection of round poufs that can be used as extra informal seating. A perfect choice for rest areas in offices, museums, libraries and other public spaces.

design:
Bejot Development Team

Product website
[website link](#)

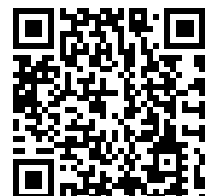

bejot:

collection advantages

Round poufs

Point is a collection of round poufs that can be used as additional informal seating, or as comfortable footstools. They come in three widths, with feet in black plastic or solid aluminum. One of the models, the POP R 450, has double casters instead of feet for better mobility, making it easier to move.

technical data

POP 900

Standard ●
Option ○

Additional equipment	CODE	
Feet made from black material	FK	●
Full aluminium feet with ABS cover / price for set for POP 450	AK5	○
Full aluminium feet with felt / price for set for POP 450	AF5	○
Full aluminium feet with ABS cover / price for set for POP 900, POP 1200	AK6	○
Full aluminium feet with felt / price for set for POP 900, POP 1200	AF6	○

dimensions

POP 900

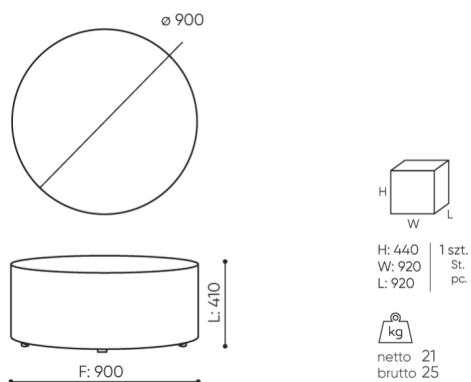

POP 900

- A seat height: overall dimensions
- B seat height
- C chair height: overall dimensions
- D backrest height
- F chair width: overall dimensions
- G seat width
- H backrest width
- K height from the floor to the armrest
- M chair depth: overall dimensions
- N seat depth / seat length

Dimensions are approximate and may vary depending on the selected product configuration. The requirements of the standard are always met.

materials available for collection

1st price group	Bond, Fenno, Keimo, Sawana
2nd price group	Alpa, Charles, Charles - Studio Design, Cura, Era - Studio Design, Pastel, Roccia, Valencia
3rd price group	Ally, Ally SD, Alpa-Studio Design, Blazer, Cura SD, Easy SD, Oceanic, Rhythm, Silvertex , Silvertex - Studio Design, Synergy, Synergy - Studio Design, Valencia - Studio Design
4th price group	Heritage, Oceanic-Studio Design, Remix - Studio Design
5th price group	Accessoire, Steelcut Trio 3
Leather	Leather

