

lumi

LM 5R2

: product card



The Lumi chair stands out with its minimalist design that perfectly fits into interior design trends. Its slim silhouette and perfectly contoured backrest ensure not only an elegant look but also high user comfort.

design:
Włodzimierz Orsztynowicz

Product website
[website link](#)



bejot:

collection advantages

Chaise de bureau | gante

Sa silhouette lancée, son appui-tête intégré, ses accoudoirs futuristes et son mécanisme en aluminium poli en font un siège idéal pour les bureaux | gants et les bureaux | domicile.

deux hauteurs de dossier

Les fauteuils pivotants Lumi sont disponibles en deux hauteurs de dossier – avec ou sans appui-tête intégré. Les fauteuils Lumi conviennent aussi bien aux bureaux | gants qu'aux bureaux modernes.

une collection de chaises aux multiples possibilités

Le grand avantage de toute la collection Lumi est la large gamme de bases et jusqu'à trois types de baquets distinctifs. Cela permet de conserver un style commun au bureau, la salle de conférence et au salon.

technical data

LM 5R2

Standard ●
Option ○

Mechanism	CODE	
Rotatable, with height adjustment	A	●
Rotable mechanism with 3d motion function (forward, backward and sideways) and height adjustment	O5	○
Base		
Polished aluminium 5-star base (chrome effect) Ø700	36	●
Powder coated aluminium 5-star base (colors according to Bejot sampler book) Ø 700	37	○
Armrests		
Without armrests		●
Armrests made of Ø 18 pipe, powder coated without a pad	P26P	○
Armrests of flat bar, powder coated + leather pad	P23P	○
Castors	CODE	
Hard castors for soft floors Ø 65 with auto-brake	DEMA	●
Soft castors for hard floors Ø 65 with auto-brake	DEMAD	○
Universal castors without brake, color white	RL W5	○
Stitches	CODE	
Stitches in the colour of upholstery.		●
White, grey, orange, red, green or black stitches for leather-upholstered armchairs or for keimo, valencia, silvertex collection upholstery.		○

dimensions

LM 5R2

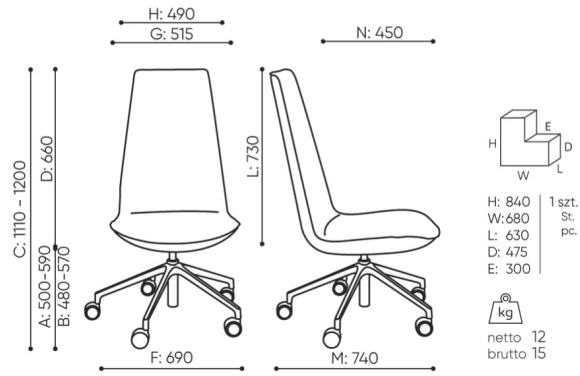

LM 5R2

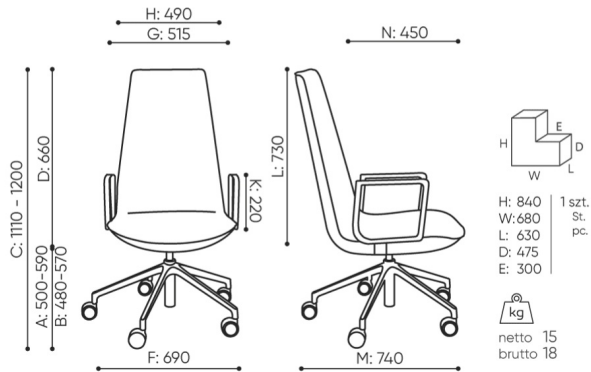

LM 5R2 + P23P

bejot:lumi

- A seat height: overall dimensions
- B seat height: measured according to the norm PN EN 13335 - 1
- C chair height adjustment
- D backrest height adjustment
- E headrest height adjustment
- F dimensional width chair / base
- G seat width
- H backrest width
- I width between armrests
- K armrest height adjustment
- L backrest length
- M dimensional chair depth
- N seat depth adjustment / seat length

Dimensions are approximate and may vary depending on the selected product configuration. The requirements of the standard are always met.

materials available for collection

1st price group	Bond, Fenno, Keimo, Sawana
2nd price group	Alpa, Charles, Charles - Studio Design, Cura, Era - Studio Design, Pastel, Roccia, Valencia
3rd price group	Ally, Ally SD, Alpa-Studio Design, Blazer, Cura SD, Easy SD, Oceanic, Silvertex , Silvertex - Studio Design, Synergy, Synergy - Studio Design, Valencia - Studio Design
4th price group	Heritage, Oceanic-Studio Design, Remix - Studio Design
5th price group	Accessoire, Steelcut Trio 3
Leather	Leather
Metal	Metal - powder coated, Metal ALU/chrom

bejot:lumi



